



60

YEARS

ELVEDES®

2025

PRODUCT CATALOG

LET'S GO THE EXTRA MILE



Argentina
Austria
Belgium
Bulgaria

Canada
Costa Rica
Croatia
Czech Republic

Denmark
France
Germany
Greece

Hungary
Italy
Latvia
Mexico

Panama
Poland
Portugal
Romania

Slovenia
South-Africa
Spain
Switzerland

The Netherlands
Ukraine
United Kingdom



Welcome to Elvedes, your trusted partner in the world of cycling since 1965. Dedicated to providing premium quality products, we ensure that every bike can be safely brought back to the road. From our base in the Netherlands, we proudly support bicycle manufacturers, wholesalers and retailers all across the globe.

In the world of cycling and beyond, Elvedes is **your reliable partner for just-in-time deliveries**.

Our well-structured stock-keeping strategy of semi-manufactured goods and our advanced assembly facility allows us to deliver innovative, high-quality solutions tailored to the needs of cycling professionals and enthusiasts alike.

This catalog presents an extensive range of our aftermarket products and **serves as a comprehensive handbook** for selecting the right disc brake pads, bearings, and bottom brackets using Elvedes' product guides.

Wherever in the world you're reading this, thank you for choosing Elvedes as your trusted partner. Our product catalog is a gateway to exploring premium quality products as well as an open invitation to new distribution partners to join us on our journey. With craftsmanship and enthusiasm, **we spread the joy of cycling together**.

INDEX

01 BRAKE

- 10 Rim brake pads
- 14 Disc brake pads
- 24 Disc brake rotors
- 27 Caliper adapters
- 28 Caliper bolts
- 29 Disc brake parts
- 30 Disc brake systems

02 CABLE

- 33 Superflex cables
- 35 Inner cables
- 38 Outer cables
- 39 Cable kits
- 43 Cable parts

03 HYDRO

- 49 Extending & repairing
- 50 Original brands
- 52 Hydro components
- 55 O-rings

04 ROTATION

- 57 Bearings
- 59 Headset bearings
- 61 Headset parts
- 62 Pulley wheels
- 64 Bottom bracket guide
- 65 Bottom brackets
- 70 Bottom bracket parts

05 TOOLS & MAINTENANCE

- 74 Maintenance
- 75 Cable tools
- 76 Hose measurement kit
- 77 Hydro tools
- 80 More tools
- 81 Bottom bracket tools

06 WORKSHOP

- 83 Transit
- 84 Boxer
- 85 Partner
- 86 Doblo
- 87 Caddy
- 88 Padfinder
- 89 Discovery
- 90 Bleed station

OUR HISTORY

On February 8, 1965, Lourens van der Spruijt officially registered Technische Handelsonderneming L. van der Spruijt with the Chamber of Commerce. The company's first invoice was issued the following day, February 9, to the bicycle specialist Staals in Utrecht, marking the beginning of a journey that continues to this day.

In the early years, Lourens supplied products directly to specialty shops, offering a range of moped parts such as sprockets, pistons, buddy seats, and notably, raised handlebars. These extra-high handlebars created a demand for longer cables, and the need for cables expanded beyond the two-wheeler sector into various other industries.

To meet this demand, Lourens established the brand Elvedes, named after the initials of L. van der Spruijt (L-V-D-S), pronounced as "ell-vee-dez".

Around 1977, the company decided to focus exclusively on the assembly and distribution of mechanical control cables, serving both the two-wheeler industry and other sectors. The Elvedes brand expanded its reach to wholesalers and, subsequently, to retailers.

Over the years, Elvedes became a trusted name in the Benelux region and beyond, gaining popularity among cycling enthusiasts and various industries. In 2002, Lourens passed the leadership to his sons, Carl and Peter, who continued to grow the brand. They diversified the product range, transforming Elvedes into a one-stop shop.

60 years after its founding, Elvedes has flourished into a remarkable family business. Its products are now available in the aftermarket worldwide, symbolizing quality, innovation, and reliability.

60 YEARS ELVEDES

1965



Founding

In 1965, Lourens van der Spruijt founded 'Trading company L. van der Spruijt', setting the stage for what would later become Elvedes. Operating from his Opel Rekord station wagon, he travelled across the Netherlands, selling bicycle and moped parts like cables, gears, and handlebars to retailers and workshops. Lourens handled production of bike and moped cables in small batches and was known for his customer-first approach and visited clients personally to build strong relationships. His dedication and entrepreneurial spirit established the foundation for Elvedes' future success.

Direct Sales

Noticing a demand for longer cables for popular mopeds like Kreidler and Zündapp (handlebars were going up at that time) Lourens began producing custom cables to meet this need. In 1968, he shifted from direct sales to retailers, choosing to work with wholesalers and bike manufacturers. This strategic move expanded Elvedes' reach and allowed Lourens to scale up production while maintaining quality. Targeting wholesalers provided access to a broader market and drove early growth.



1968

1977



Cable Grease Nipple

In 1977, Lourens introduced the innovative cable grease nipple, a small but impactful product that simplified cable maintenance and extended the life span. The grease nipple became a widely-used component and highlighted Elvedes' commitment to technical advancements, strengthening its reputation as an innovative brand.

New Building in Elshout

By 1989, Elvedes had grown significantly and required more space. The company moved to a new 450 m² building in Elshout, marking a milestone in its ability to expand production. This facility enabled increased efficiency and allowed Elvedes to handle growing demand, positioning the company as an established player in the industry.



1989

2002

Next Generation - From Father to Sons

In 2002, Lourens' sons joined the company, with Carl entering in 1999 and Peter in 2002. This transition was the beginning of a new era as the brothers began taking over daily operations, allowing their father to enjoy his well-earned retirement. With this new generation Elvedes continued to grow, with a fresh drive for innovation and modernization that honoured the company's roots.



2012



Filed for Patent

Elvedes filed its first patent in 2012 for a specialized cable clamp bolt tailored for Shimano roller brakes. This innovation underlined the company's dedication to advancing technology in the cycling industry. Securing this patent protected Elvedes' intellectual property, distinguishing it as a leader in product development and enhancing its reputation for innovation.

New Building in Nieuwkuijk

Elvedes' growth necessitated a move to a larger, 2600 m² facility in Nieuwkuijk in 2015. The new building allowed for streamlined logistics and increased production and stock capacity, enabling Elvedes to meet rising demand. With this transition the company's was ready for future expansion.



2015

2025



60-Year Anniversary!

As Elvedes approaches its 60th anniversary in 2025, it celebrates six decades of growth and innovation. From its humble beginnings to becoming a leading name in the bicycle parts industry, Elvedes remains true to its core values of quality and customer service. This milestone is both a celebration and a reflection on the company's enduring legacy and achievements with a team of highly committed colleagues.

A LITTLE EXTRA

'Plus' is a word derived from Latin, meaning 'more.' Ever since Elvedes was founded, we have always strived to do a little more. When we introduced high steerers for mopeds in the sixties, the existing moped cables needed extra length. This demand led Elvedes to add more varieties of cables to the range—not only for mopeds and bicycles, but for all kinds of custom purposes.

Over the years, more and more bicycle service parts have been added to our collection. We offer convenient displays for better organization and a more efficient workshop. We have disc brake pads—not just the common types—but also rim brake pads with special compounds that are quieter and more powerful. Our twist-fit bottom brackets not only provide greater stability for the bearings but are also more durable, as the bearings themselves can be replaced when worn. And much more.

We believe that these smart additions and solutions make life just a little more convenient for mechanics and consumers alike. To draw more attention to these products, we are introducing the Elvedes + label, which makes them easily recognizable throughout this catalog. The label, along with a single highlighted sentence, explains why each item is such a valuable addition.



Elvedes +

This label can be found at different items throughout the catalog. It tells you why this particular item is such a big plus.

BRAKE 1



COMPOUND GUIDE

**BLACK COMPOUND**

- For aluminium rims

CITY BIKE

TREKKING BIKE

ROAD BIKE

E-BIKE

**BLACK/RED COMPOUND**

- For aluminium rims

MTB

TREKKING BIKE

**WHITE COMPOUND**

This compound is specially developed for comfortable, powerful braking. Its unique white compound is silent and doesn't contaminate the rims with black residue.

- For aluminium rims
- For more brake power
- For less noise

ROAD BIKE

E-BIKE

BMX

**BLUE COMPOUND**

- For carbon rims only

ROAD BIKE

BMX

**GREY COMPOUND**

- For aluminium rims
- Wear-resistant and longer life span
- Excellent brake power

E-BIKE

CITY BIKE

TREKKING BIKE



PACKAGING OPTIONS

**XXXX-CARD**

All rim brake pads can be ordered per card, containing 1 pair.

**XXXX-BOX**

Selected rim brake pads can be ordered per box, containing 25 pairs.

Fits Caddy display (page 87)

**XXXX-BAG100**

Selected rim brake pads can be ordered in a bulk bag, containing 100 pairs.



6807
-CARD/-BOX
V-brake pads
55 mm



6816
-CARD/-BOX/-BAG100
V-brake pads
70 mm symmetrical



6806
-CARD/-BOX/-BAG100
V-brake pads
72 mm



6828
-BOX
V-brake pads
72 mm
ABS design



6815
-CARD/-BOX
V-brake pads
72 mm
Special groove design



6832
-CARD/-BOX
V-brake pads
72 mm
More brake power
Less noise



6804
-CARD
V-brake pads
72 mm cartridge



6802
-CARD
V-brake pads
72 mm cartridge
Special groove design



6805
-CARD/-BOX
V-brake pads
72 mm
replacement pad
for **6802, 6804**



6839
-CARD
V-brake pads
72 mm
replacement pad
for **6802, 6804**
For carbon rims
only



6803
-CARD
V-brake pads
72 mm
replacement pad
for **6802, 6804**
Special groove
design

BRAKE

- Rim brake pads
- Disc brake pads
- Disc brake rotors
- Caliper adapters
- Caliper bolts
- Disc brake parts
- Disc brake systems

CABLE

- Superflex cables
- Inner cables
- Outer cables
- Cable kits
- Cable parts

HYDRO

- Extending & repairing
- Original brands
- Hydro components
- O-rings

ROTATION

- Bearings
- Headset bearings
- Headset parts
- Pulley wheels
- Bottom bracket guide
- Bottom brackets
- Bottom bracket parts

TOOLS & MAINTENANCE

- Maintenance
- Cable tools
- Hydro tools
- More tools
- Bottom bracket tools

WORKSHOP

- Transit
- Boxer
- Partner
- Caddy
- Padfinder
- Discovery
- Bleed station



6808
-CARD
 Cantilever
 70 mm symmetrical



6812
-BOX
 Cantilever
 72 mm



6833
-CARD
 Cantilever
 55 mm cartridge
 Cyclocross



6834
-CARD
 Cantilever
 55 mm replacement
 pad for **6833**
 Cyclocross



6842
-CARD/-BOX
 Road
 Compatible with
 Shimano
 55 mm



6848
-CARD
 Road
 Compatible with
 Shimano
 55 mm
 More brake power
 Less noise



6847
-CARD
 Road
 Compatible with
 Shimano
 55 mm cartridge



6835
-CARD
 Road
 Compatible with
 Shimano
 55 mm light weight
 cartridge
 More brake power
 Less noise



6845
-CARD
 Road
 55 mm light weight
 cartridge
 For carbon rims only



6810
-CARD/-BOX
 Road
 Compatible with
 Shimano
 55 mm
 replacement pad
 for **6833, 6835,**
6845, 6847



6837
-CARD
 Road
 Compatible with
 Shimano
 55 mm replacement
 pad for **6833, 6835,**
6845, 6847
 More brake power
 Less noise



6827
-CARD
 Road
 Compatible with
 Shimano
 55 mm replacement
 pad for **6833, 6835,**
6845, 6847
 For carbon rims only



6813
-CARD
Caliper
X-groove design



6843
-CARD
Caliper
X-groove design
More brake power
Less noise



6814
-CARD/-BOX/-BAG100
Power pads
Compatible with
Magura HS11/33



6840
-CARD/-BOX/-BAG100
Power pads
Compatible with
Magura HS11/33
More brake power
Less noise



6849
-CARD/-BOX/-BAG100
Power pads
Compatible with
Magura HS11/33
Wear-resistant



6844
-CARD
Road
Power pads
Compatible with
Magura HS11/33
Wear-resistant



6846
-CARD
Road
Compatible with
Campagnolo
55 mm cartridge



6836
-CARD
Road
Compatible with
Campagnolo
55 mm light weight
cartridge
More brake power
Less noise



6822
-CARD
Road
Compatible with
Campagnolo
55 mm
replacement pad
for **6836, 6844,**
6846



6838
-CARD
Road
Compatible with
Campagnolo
55 mm
replacement pad
for **6836, 6844,**
6846
More brake power
Less noise



6826
-CARD
Road
Compatible with
Campagnolo
55 mm
replacement pad
for **6836, 6844,**
6846
For carbon rims
only

BRAKE

- Rim brake pads
- Disc brake pads
- Disc brake rotors
- Caliper adapters
- Caliper bolts
- Disc brake parts
- Disc brake systems

CABLE

- Superflex cables
- Inner cables
- Outer cables
- Cable kits
- Cable parts

HYDRO

- Extending & repairing
- Original brands
- Hydro components
- O-rings

ROTATION

- Bearings
- Headset bearings
- Headset parts
- Pulley wheels
- Bottom bracket guide
- Bottom brackets
- Bottom bracket parts

TOOLS & MAINTENANCE

- Maintenance
- Cable tools
- Hydro tools
- More tools
- Bottom bracket tools

WORKSHOP

- Transit
- Boxer
- Partner
- Caddy
- Padfinder
- Discovery
- Bleed station

HOW TO EXTEND THE LIFE SPAN OF YOUR DISC BRAKE PADS

Bedding in Disc Brake Pads for Better Braking Power, Less Noise, and a Longer Lifespan

First, clean the rotor with brake cleaner and install the new brake pads.

STEP 1

Increase the contact surface between the brake pad compound and the rotor to prevent squeaking and abrupt braking behavior.

Drive for approximately 2 minutes at a speed of around 25 km/h while lightly holding the brake (dragging the brake) to gradually wear the compound onto the brake disc, maximizing the contact surface.

STEP 2

Transfer friction material from the brake pad into the pores of the brake disc surface to enhance braking power and reduce noise by introducing heat into the brake compound.

Drive at a speed of around 25 km/h and brake down to approximately 5 km/h (without stopping completely). Repeat this process 10 times. The brake pads are now ready for use.



GREY

- + Super soft compound
- + Noise reducing
- + For any noisy disc brake
- + Excellent problem solver



BLUE

- + Soft compound
- + Comfortable and reliable
- + For gravel bike, road bike, trekking bike and MTB
- + Excellent for daily and sporty use



BLACK

- + Medium compound
- + Powerful
- + For cargo bike, e-bike and MTB
- + Excellent for heavy duty

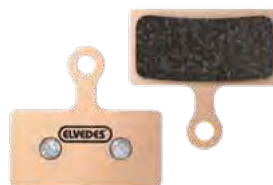

GOLD

- + Hard compound
- + Wear and heat resistant
- + For commercial cargobike, e-bike and downhill MTB
- + Excellent for intensive use

PACKAGING OPTIONS



XXXX - CARD

All disc brake pads can be ordered per card, containing 1 pair.

Necessary pins and clips included with all types of disc brake pads on card.
Fits Discovery display (page 89)



XXXX - BOX

Selected disc brake pads can be ordered per box, containing 10 pairs.

Fits Padfinder display (page 88)



XXXX - BOX25

Selected disc brake pads can be ordered per box, containing 25 pairs.

Fits Padfinder display (page 88)

BRAND	MODEL	GREY	BLUE	BLACK	GOLD
Alhonga	SNG mechanical		6872	6872MC	
Assess	C420, C425, C470		6886	6886MC	
	C430		6881		
Avid	BB3, BB5		6886	6886MC	
	BB7, Juicy		6855	6855MC	6855S
	Code, Code 5		6882		
	Code > 2011		6895	6895MC	6895S
	DB1, DB3	6906T	6906	6906MC	6906S
	Elixir	6890T	6890	6890MC	6890S
	X0, X7, X9 Trail		6898	6898MC	6898S
Brekr	F250	6890T	6890	6890MC	6890S
Campagnolo		6908T			
Cannondale	Coda		6865		
Clarks	Clout 1, S2	6854T	6854	6854MC	6854S
	M1,M2, M3, CMD-22(FM), CMD-23, CMD-27	6894T	6894	6894MC	6894S
	M4	6891T	6891	6891MC	6891S
	Exo, Skeletal		6860		
	CMD-24, HDB-540, HDB-600, HDB-790	6859T	6859	6859MC	6859S
	CMD-9, CMD-17(R)		6886	6886MC	
	CMD-15		6855	6855MC	6855S
	CMD-5, CMD-6, CMD-7, CMD-12		6913		
Cowboy	Cruiser (ST), C2, C3, Classic, Cross (ST)	6907T	6907	6907MC	6907S
Diatech	Anchor		6880		
	Twincam		6864		
Elvedes	HP4000	6890T	6890	6890MC	6890S
	MP1000 PM	6894T	6894	6894MC	6894S
	MP1000 FM	6907T	6907	6907MC	6907S
Formula	4-Racing, B4 Team		6869		
	C1, Cura, Cura-E, Mega, R1(R), RO(R), RX, The one		6893	6893MC	6893S
	Cura 4		6909	6909MC	6909S
	Extreme		6869		
	Evoluzione		6867		
	Oro		6863		6863S
FSA	K-Force DB-TX-9000	6894T	6894	6894MC	6894S
	Afterburner DB-TX-9150	6894T	6894	6894MC	6894S
Giant	MPH 2000		6852		
	MPH 2001 - 2003, MPH-2, MPH-3		6861		
	Root	6854T	6854	6854MC	6854S
Grimeca	System 8, 12, 16		6853		
	System 13		6869		
Hayes	Dominion A4		6910	6910 MC	6910S

BRAND	MODEL	GREY	BLUE	BLACK	GOLD
Hayes	Dyno, Stroker Ryde		6888		6888S
	El Camino		6885		
	HFX, MX 1		6850		6850S
	Prime		6896		6896S
	Stroker Ace		6892		
	Stroker Carbon, Gram, Trail, GX2		6889		6889S
	MX2, MX3, MX4, Sole	6862T	6862	6862MC	
Hope	C2, O2		6852		
	DH4, M4 2002		6871		
	E4, RX4-SH		6903		
	Mini		6870		
	Mono 6 2007, 6-Ti 2004, Moto M6		6876		
	Mono M4		6853		
	Mono Mini		6877		
	Mono Trial, Trial Zone		6887		
	(Moto) V2		6883		
	V4		6899		6899S
	X2		6911	6911MC	6911S
	XC4		6873		
Logan			6874		
Magura	Clara 2000 - 2001, Louise 1999 - 2001		6851		
	Clara 2001 - 2002, Louise (FR) 2002 - 2006		6857		
	Gustav M 2000 - 2011		6878		
	Julie 2001 - 2008		6856		
	Julie HP, Louise > 2007, Louise Bat, Louise Carbon, Marta > 2009		6884		6884S
	Marta 2002 - 2008, Marta SL 2003 - 2008		6860		
	MT2, MT4, MT6, MT8, MTC4, MT Sport, MT Trail (rear)	6897T	6897	6897MC	6897S
	MT A2		6916		
	MT5, MT7, MTC5, MT Thirty, MT Trail (front)	6902T	6902 6904	6902MC 6904MC	6902S 6904S
Promax	DC320, 610, 610J		6879		
	DC600		6850		6850S
	DC710, 720, 913, Decipher, DSK-300®, 310, 330R, 715, Render (R)		6886	6886MC	
	DC901, 951		6880		
	DC905, 907, 908, DSK-950		6855	6855MC	6855S
	DC910		6851		
	Decode R DSK-718R, DSK-909, E-Capsule, F1, Lucid, Solve	6854T	6854	6854MC	6854S
	DSK-810	6862T	6862	6862MC	
Lucid P4		6853			
Quad	QHD-1	6854T	6854	6854MC	6854S
Rever	MCX1 PM	6894T	6894	6894MC	6894S
RST	D-Power	6854T	6854	6854MC	6854S
	DA		6866		

BRAND	MODEL	GREY	BLUE	BLACK	GOLD
Shimano	105 BR-R7070, 7170, BR-RS505	6907T	6907	6907MC	6907S
	Acera BR-M3050	6854T	6854	6854MC	6854S
	Alfine BR-S500, 501	6859T	6859	6859MC	6859S
	Alfine BR-S700, 7000	6894T	6894	6894MC	6894S
	Alivio BR-M395, 446, 4050	6854T	6854	6854MC	6854S
	Altus BR-M315, 365, 375	6854T	6854	6854MC	6854S
	BR-CX75, 77, BR-R515, 517	6894T	6894	6894MC	6894S
	BR-M355, 415, 416, 416A, 445, 447, 465, 475, 485, 486, 495, 575, BR-MT200, 400, 410, 500, BR-UR300	6854T	6854	6854MC	6854S
	BR-M545, BR-R505, BR-T605	6859T	6859	6859MC	6859S
	BR-MT420, 520	6891T	6891	6891MC	6891S
	BR-RS305	6907T	6907	6907MC	6907S
	Deore BR-M515, 515LA, 525, BR-T615	6854T	6854	6854MC	6854S
	Deore BR-M535, 595, 596	6859T	6859	6859MC	6859S
	Deore BR-M555		6858		
	Deore BR-M615, 6000, 6100, BR-R785, BR-RS785	6894T	6894	6894MC	6894S
	Deore BR-M6120	6891T	6891	6891MC	6891S
	Deore LX BR-M585, BR-T665	6859T	6859	6859MC	6859S
	Deore LX BR-T675	6854T	6854	6854MC	6854S
	Deore XT BR-M755, 755-DH		6853		
	Deore XT BR-M765, 775, 776	6859T	6859	6859MC	6859S
	Deore XT BR-M785, 8000, 8100	6894T	6894	6894MC	6894S
	Deore XT BR-M8020, 8120	6891T	6891	6891MC	6891S
	Deore XT BR-M8110	6907T	6907	6907MC	6907S
	Dura-ace BR-R9170, 9270	6907T	6907	6907MC	6907S
	GRX BR-RX400, 810	6907T	6907	6907MC	6907S
	Hone BR-M601	6859T	6859	6859MC	6859S
	Metrea BR-U5000	6907T	6907	6907MC	6907S
	Nexave BR-C501, 601	6854T	6854	6854MC	6854S
	Nexave BR-C901		6858		
	Saint BR-M757	6854T	6854	6854MC	6854S
	Saint BR-M800	6859T	6859	6859MC	6859S
	Saint BR-M810, 820	6891T	6891	6891MC	6891S
	SLX BR-M665	6859T	6859	6859MC	6859S
SLX BR-M666, 675, 7000, 7100	6894T	6894	6894MC	6894S	
SLX BR-M7120	6891T	6891	6891MC	6891S	
ZEE BR-M640	6891T	6891	6891MC	6891S	
SRAM	Apex/Force/RED/Rival AXS, DB5, Level 2P, S-300, S-900, Via GT, X0, XX	6890T	6890	6890MC	6890S
	Code, DB8, G2 RE, Guide RE		6895	6895MC	6895S
	G2 R/RS/RSC/ULT, Guide R/RS/RSC/T/ULT, Level 4P, Trail		6898	6898MC	6898S
	Apex/Force/Rival 1, Force/Rival 22, RED, S-700		6900	6900MC	6900S
	Maven		6917		
Star Union	150PYDZS/2, 220PYD, 221PYDZJ			6914MC	

BRAND	MODEL	GREY	BLUE	BLACK	GOLD
Star Union	150PYDZS/2 Pro, 220PYD Pro, 221PYDZJ Pro			6915MC	
	240PYD	6854T	6854	6854MC	6854S
Suntour	DB XCC-MC		6875		
	SR1		6879		
Tektro	Aquila MD-M500	6854T	6854	6854MC	6854S
	Aries MD-M300	6854T	6854	6854MC	6854S
	Auriga HD-E510, E515, T515		6875		
	Auriga HD-E540, E541, E545, E546, T390, T540, T541, T545			6914MC	
	Auriga HD-E500, E520, E525, E530, M290, M291, M700, T520, T525, T530	6854T	6854	6854MC	6854S
	Auriga HD-5040, 5041, E740, E741, E745, E746, E747, T740, T741, T745, T746			6915MC	
	Dorado HD-E720, E725, E730	6891T	6891	6891MC	6891S
	Dorado HD-E710		6905		
	Dorado HD-E715	6854T	6854	6854MC	6854S
	Dorado HD-E731, T731, T737, T747			6915MC	
	Draco HD-M350, M351, M352	6854T	6854	6854MC	6854S
	Draco HD-M390			6914MC	
	Gemini HD-M500, M501, M510, M520, M521	6854T	6854	6854MC	6854S
	Gemini HD-M530 (front), M535			6915MC	
	Gemini HD-M530 (rear), M3520			6914MC	
	HDC HD-M300, M301, M330	6854T	6854	6854MC	6854S
	HD-E350, E351, E3520, M275, M276, M280, M281, M285, M286, T275, T276, T280, T281, T285, T286, T385, T386, T3020, T3021, R280, R281, R285, R286	6854T	6854	6854MC	6854S
	HD-E3940, T532 (front), T5040, T5041			6915MC	
	HD-R310, R510, R3020, R3021	6907T	6907	6907MC	6907S
	HD-E395, T532 (rear)			6914MC	
	IO (N11.11)			6868	
	Junior HD-J285, J290, J2820, J2920, M282	6854T	6854	6854MC	6854S
	Lyra MD-C500			6901	
	MD-C310, C510, C550, M280, U310, U510	6854T	6854	6854MC	6854S
	Mira MD-C400	6854T	6854	6854MC	6854S
	Novela MD-M311 (IOX.11)			6912	
	Novela MD-M311 (L10.11)			6901	
	Orion HD-M735 (front), M745, M750	6891T	6891	6891MC	6891S
	Orion HD-M720, M730, M735 (rear), M740	6854T	6854	6854MC	6854S
	Vela HD-T290	6854T	6854	6854MC	6854S
	Volans HD-T533 (front), T535			6915MC	
	Volans HD-T700			6875	
	Volans HD-T710	6854T	6854	6854MC	6854S
Volans HD-T533 (rear), T3520			6914MC		
TRP	Dash Sport, HY/RD, Hylex, Hylex RS HD-C801, Parabox R, Slate X2, Spyke, Spyre	6854T	6854	6854MC	6854S
	G-Spec, Quadiem, Slate T4, Zurich	6891T	6891	6891MC	6891S
	Hylex HD-C810, Hylex RS HD-C811, HD-T910	6907T	6907	6907MC	6907S
VanMoof	A5, S5	6862T	6862	6862MC	
	S3, X3	6906T	6906	6906MC	6906S
Zoom			6872	6872MC	

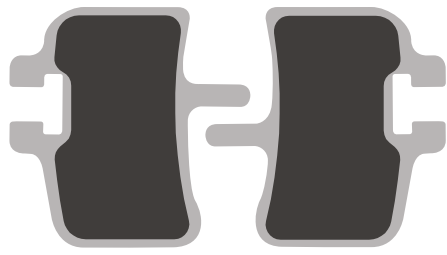

6850 -CARD
6850 S -CARD

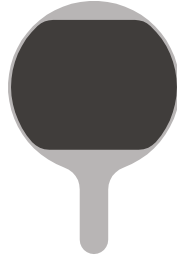

6851 -CARD

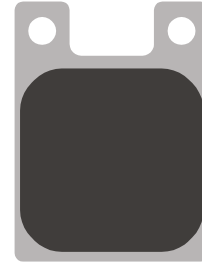

6852 -CARD

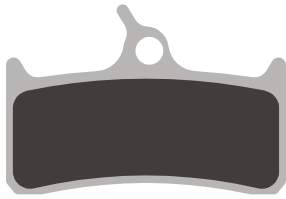

6853 -CARD

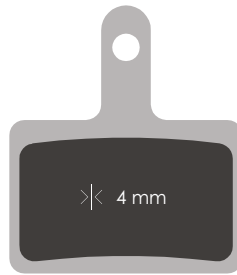

6854 T -CARD -BOX -BOX25
6854 -CARD -BOX -BOX25
6854 MC -CARD -BOX -BOX25
6854 S -CARD -BOX -BOX25

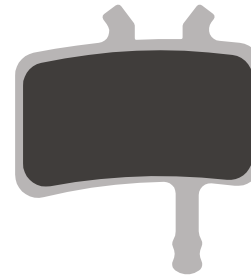

6855 -CARD
6855 MC -CARD
6855 S -CARD

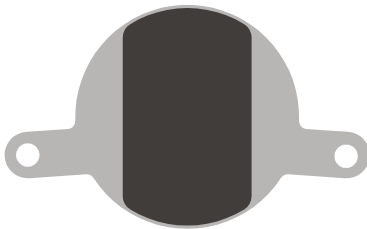

6856 -CARD



6857 -CARD

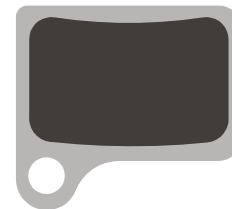

6858 -CARD

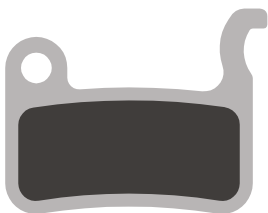

6859 T -CARD
6859 -CARD
6859 MC -CARD -BOX
6859 S -CARD



6860 -CARD

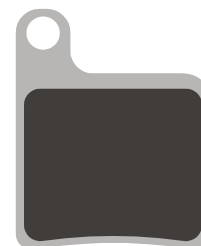

6861 -CARD

BRAKE

Rim brake pads

Disc brake pads

Disc brake rotors

Caliper adapters

Caliper bolts

Disc brake parts

Disc brake systems

CABLE

Superflex cables

Inner cables

Outer cables

Cable kits

Cable parts

HYDRO

Extending & repairing

Original brands

Hydro components

O-rings

ROTATION

Bearings

Headset bearings

Headset parts

Pulley wheels

Bottom bracket guide

Bottom brackets

Bottom bracket parts

TOOLS & MAINTENANCE

Maintenance

Cable tools

Hydro tools

More tools

Bottom bracket tools

WORKSHOP

Transit

Boxer

Partner

Caddy

Padfinder

Discovery

Bleed station

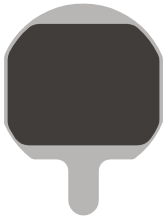

6862 T -CARD
6862 -CARD
6862 MC -CARD



6863 -CARD
6863 S -CARD



6864 -CARD



6865 -CARD

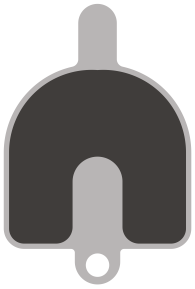

6866 -CARD



6867 -CARD

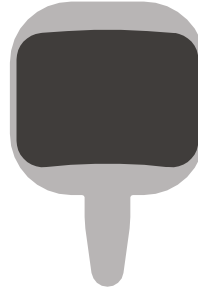

6868 -CARD



6869 -CARD

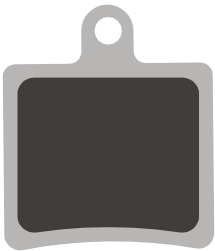

6870 -CARD

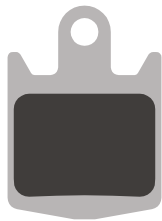

6871 -CARD



6872 -CARD
6872 MC -CARD

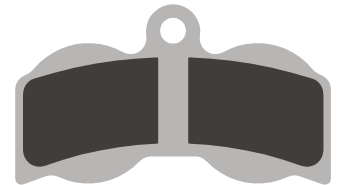

6873 -CARD

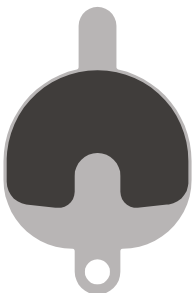

6874 -CARD

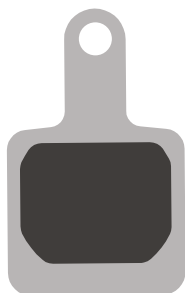

6875 -CARD

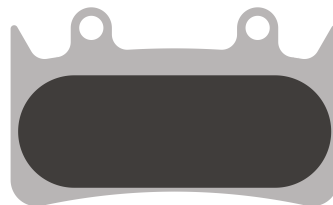

6876 -CARD

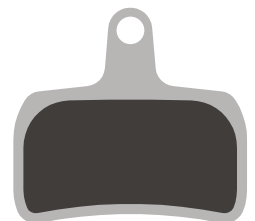

6877 -CARD

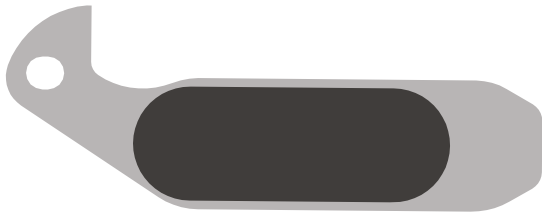

6878 -CARD



6879 -CARD

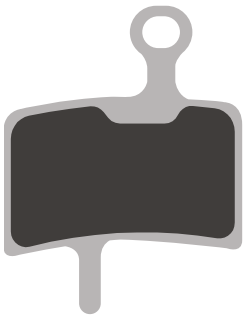

6880 -CARD

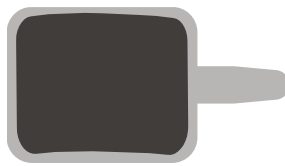

6881 -CARD

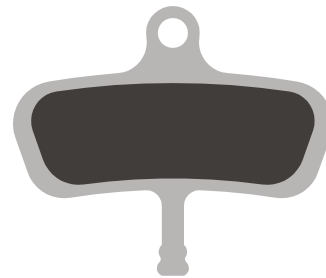

6882 -CARD

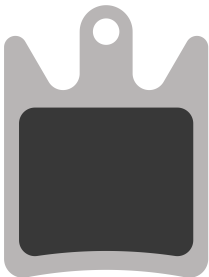

6883 -CARD

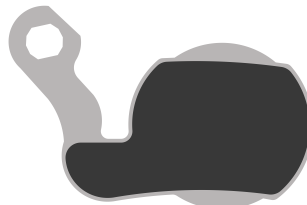

6884 -CARD
6884 S -CARD



6885 -CARD

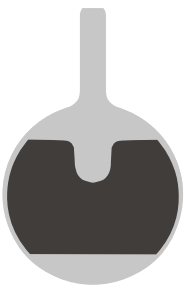

6886 -CARD
6886 MC -CARD

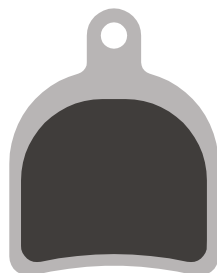

6887 -CARD

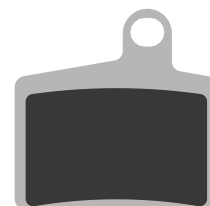

6888 -CARD
6888 S -CARD

BRAKE

Rim brake pads

Disc brake pads

Disc brake rotors

Caliper adapters

Caliper bolts

Disc brake parts

Disc brake systems

CABLE

Superflex cables

Inner cables

Outer cables

Cable kits

Cable parts

HYDRO

Extending & repairing

Original brands

Hydro components

O-rings

ROTATION

Bearings

Headset bearings

Headset parts

Pulley wheels

Bottom bracket guide

Bottom brackets

Bottom bracket parts

TOOLS & MAINTENANCE

Maintenance

Cable tools

Hydro tools

More tools

Bottom bracket tools

WORKSHOP

Transit

Boxer

Partner

Caddy

Padfinder

Discovery

Bleed station

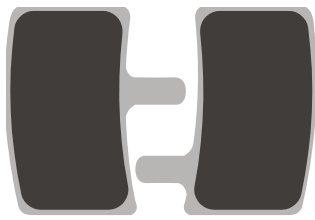

6889 -CARD
6889 S -CARD

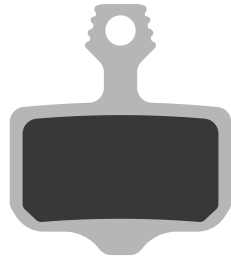

6890 T -CARD -BOX
6890 -CARD -BOX
6890 MC -CARD -BOX
6890 S -CARD -BOX

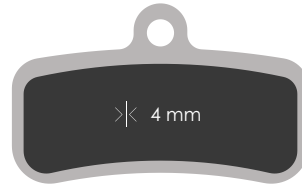

6891 T -CARD
6891 -CARD -BOX
6891 MC -CARD -BOX
6891 S -CARD -BOX -BOX25

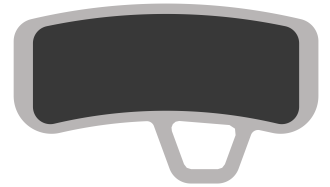

6892 -CARD

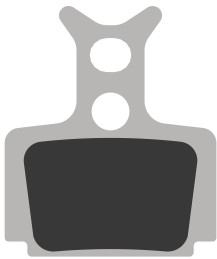

6893 -CARD
6893 MC -CARD
6893 S -CARD

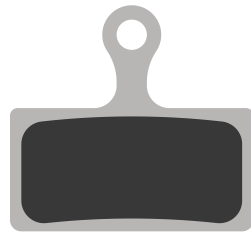

6894 T -CARD -BOX
6894 -CARD -BOX -BOX25
6894 MC -CARD -BOX -BOX25
6894 S -CARD -BOX -BOX25

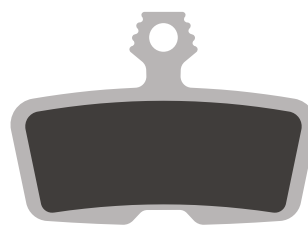

6895 -CARD
6895 MC -CARD
6895 S -CARD



6896 -CARD
6896 S -CARD

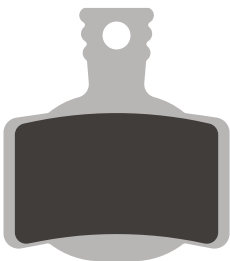

6897 T -CARD -BOX
6897 -CARD -BOX
6897 MC -CARD -BOX
6897 S -CARD -BOX



6898 -CARD -BOX
6898 MC -CARD -BOX
6898 S -CARD -BOX

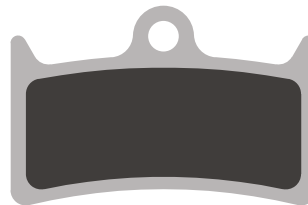

6899 -CARD
6899 S -CARD

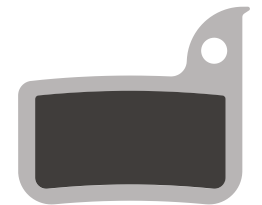

6900 -CARD -BOX -BOX25
6900 MC -CARD -BOX -BOX25
6900 S -CARD -BOX -BOX25

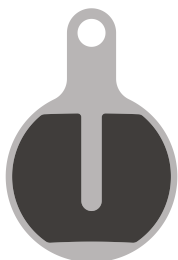

6901 -CARD

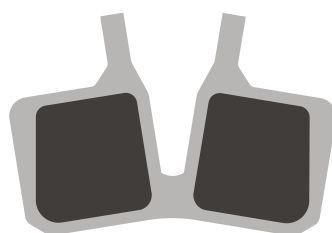

6902 T -CARD
6902 -CARD -BOX -BOX25
6902 MC -CARD -BOX -BOX25
6902 S -CARD -BOX -BOX25

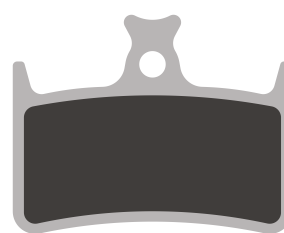

6903 -CARD



6904 -CARD
6904 MC -CARD
6904 S -BOX25

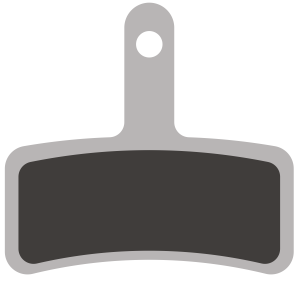

6905 -CARD

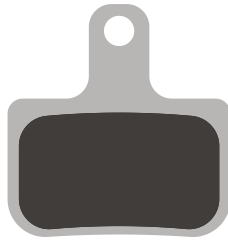

6906 T -CARD
6906 -CARD -BOX -BOX25
6906 MC -CARD -BOX
6906 S -CARD -BOX -BOX25

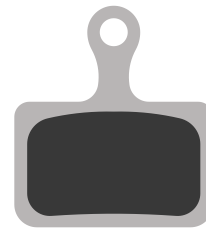

6907 T -CARD -BOX
6907 -CARD -BOX -BOX25
6907 MC -CARD -BOX
6907 S -CARD

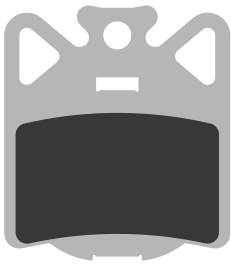

6908 T -CARD

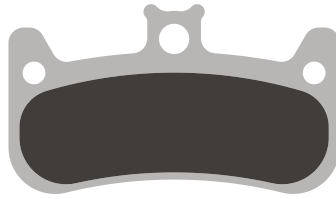

6909 -CARD
6909 MC -CARD
6909 S -CARD

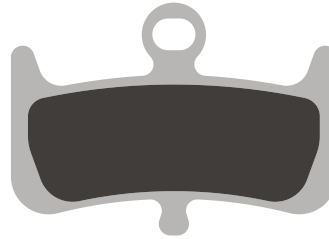

6910 -CARD
6910 MC -CARD
6910 S -CARD

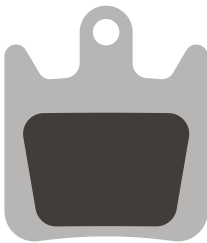

6911 -CARD
6911 MC -CARD
6911 S -CARD

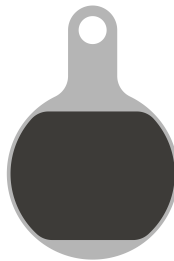

6912 -CARD

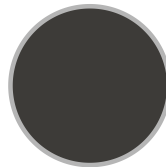

6913 -CARD

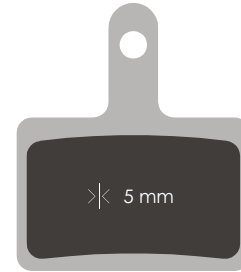

6914 MC -CARD



6915 MC -CARD



6916 -CARD

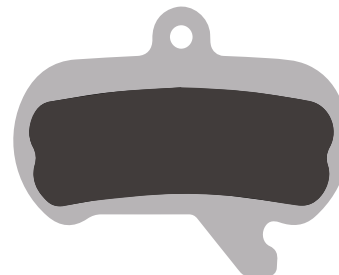

6917 -CARD

BRAKE

Rim brake pads

Disc brake pads

Disc brake rotors

Caliper adapters

Caliper bolts

Disc brake parts

Disc brake systems

CABLE

Superflex cables

Inner cables

Outer cables

Cable kits

Cable parts

HYDRO

Extending & repairing

Original brands

Hydro components

O-rings

ROTATION

Bearings

Headset bearings

Headset parts

Pulley wheels

Bottom bracket guide

Bottom brackets

Bottom bracket parts

TOOLS & MAINTENANCE

Maintenance

Cable tools

Hydro tools

More tools

Bottom bracket tools

WORKSHOP

Transit

Boxer

Partner

Caddy

Padfinder

Discovery

Bleed station

ROTORS IN ORIGINAL THICKNESS FOR THE ORIGINAL BRAKE FEELING



BRAND	MODELS	THICKNESS
Formula	All models	1.8 mm
Hayes	All models	1.8 mm
Hope	All models	1.8 mm
Shimano	All models	1.8 mm
SRAM / Avid	All models	1.8 mm
Magura	All models	2.0 mm
Tektro	TR-16, 19, 22, 24, 35, 46, 47, 52, 53	1.8 mm
	TR-17, 45, 47E, 54	2.3 mm
TRP	RC03M	1.8 mm
	RS01M, RS02M	1.8 mm
	TR-25, 29, 33	1.8 mm
	RC01E, 03E, 04E	2.3 mm
	RS01E	2.3 mm
	TR-42	2.3 mm

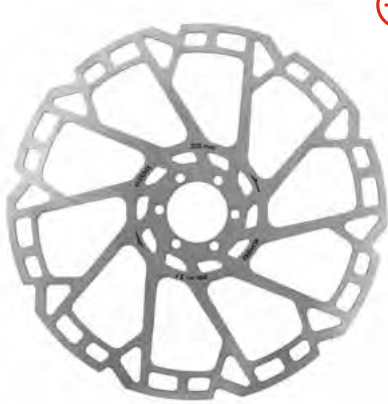

6-HOLE ROTOR

Stainless steel, excluding bolts

2024111	Ø140 mm	1.8 mm
2023026	Ø160 mm	1.8 mm
2023027	Ø180 mm	1.8 mm
2023028	Ø203 mm	1.8 mm
2023029	Ø220 mm	1.8 mm
2023030	Ø160 mm	2.0 mm
2023031	Ø180 mm	2.0 mm
2023032	Ø203 mm	2.0 mm
2023033	Ø220 mm	2.0 mm
2023035	Ø180 mm	2.3 mm
2023036	Ø203 mm	2.3 mm
2023037	Ø220 mm	2.3 mm



CENTRA-LOCK ROTOR

Stainless steel, excluding lock-ring

2024112	Ø140 mm	1.8 mm
2023038	Ø160 mm	1.8 mm
2023039	Ø180 mm	1.8 mm
2023040	Ø203 mm	1.8 mm
2023041	Ø220 mm	1.8 mm
2023042	Ø160 mm	2.0 mm
2023043	Ø180 mm	2.0 mm
2023044	Ø203 mm	2.0 mm
2023045	Ø220 mm	2.0 mm
2023047	Ø180 mm	2.3 mm
2023048	Ø203 mm	2.3 mm
2023049	Ø220 mm	2.3 mm



6-HOLE ROTOR WITH SENSOR MAGNET

Stainless steel, excluding bolts

2023050	Ø160 mm	1.8 mm
2023051	Ø180 mm	1.8 mm
2023052	Ø203 mm	1.8 mm



CENTRA-LOCK ROTOR WITH SENSOR MAGNET

Stainless steel, excluding lock ring

2023054	Ø160 mm	1.8 mm
2023055	Ø180 mm	1.8 mm
2023056	Ø203 mm	1.8 mm

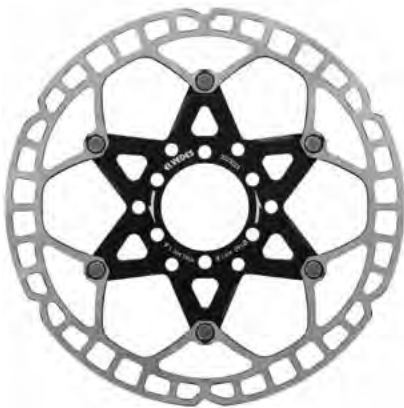

LIGHT WEIGHT 6-HOLE ROTOR

Stainless steel, aluminium core, excluding bolts
Thickness: 1.8 mm

2023022	Ø140 mm	85 g
2023023	Ø160 mm	105 g

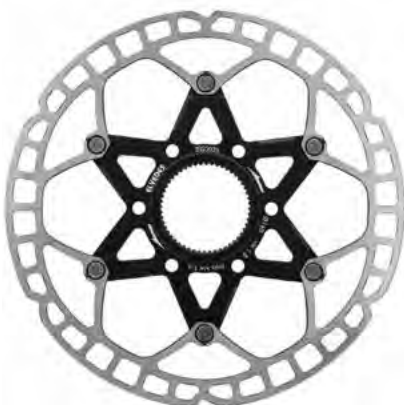

LIGHT WEIGHT CENTRA-LOCK ROTOR

Stainless steel, aluminium core, excluding lock ring
Thickness: 1.8 mm

2023024	Ø140 mm	99 g
2023025	Ø160 mm	117 g

BRAKE

- Rim brake pads
- Disc brake pads
- Disc brake rotors
- Caliper adapters
- Caliper bolts
- Disc brake parts
- Disc brake systems

CABLE

- Superflex cables
- Inner cables
- Outer cables
- Cable kits
- Cable parts

HYDRO

- Extending & repairing
- Original brands
- Hydro components
- O-rings

ROTATION

- Bearings
- Headset bearings
- Headset parts
- Pulley wheels
- Bottom bracket guide
- Bottom brackets
- Bottom bracket parts

TOOLS & MAINTENANCE

- Maintenance
- Cable tools
- Hydro tools
- More tools
- Bottom bracket tools

WORKSHOP

- Transit
- Boxer
- Partner
- Caddy
- Padfinder
- Discovery
- Bleed station



SC ROTOR

Stainless steel with aluminium Centra-lock, including lock ring
Thickness: 1.8 mm

2020071	Ø140 mm
2020072	Ø160 mm
2020073	Ø180 mm
2020116	Ø203 mm



SX ROTOR

Stainless steel, 6 holes, including rotor bolts
Thickness: 1.8 mm

2014069	Ø140 mm
6820	Ø160 mm
6821	Ø180 mm
2017092	Ø203 mm



HP ROTOR

Stainless steel, 6 holes, including rotor bolts
Thickness: 1,8 mm

2018053	Ø160 mm
2019057	Ø180 mm



BMX ROTOR

Stainless steel, 6 holes, including rotor bolts
Thickness: 1.8 mm

2019055	Ø120 mm
---------	---------



LX LIGHT WEIGHT ROTOR

Stainless steel, 6 holes, including rotor bolts
Thickness: 1.8 mm

2021066	Ø160 mm	85 g
2021067	Ø180 mm	112 g



RX FLOATING ROTOR

Stainless steel and aluminium, 6 holes, including rotor bolts
Thickness: 1.8 mm

2015152	Ø140 mm
2015206	Ø160 mm
2015207	Ø180 mm
2015208	Ø203 mm



IS - PM CALIPER ADAPTERS

International standard frame/fork to post mount caliper



CP2017071
Ø160 front
Ø140 rear

CP2017072
Ø180 front
Ø160 rear

CP2015167
Ø180 front

CP2015162
Ø203 front



CP2015168
Ø203 rear

CP2022067
Ø220 rear

PM - PM CALIPER ADAPTERS

Post mount frame/fork to post mount caliper



CP2016117
Ø140 → Ø160
Ø160 → Ø180

CP2015158
Ø160 → Ø180
<2013 front

CP2015159
Ø160 → Ø203

CP2018058
Ø180 → Ø203



CP2022064
Ø160 → Ø220

CP2022065
Ø180 → Ø220

CP2022066
Ø203 → Ø220

FM - PM CALIPER ADAPTERS

Flat mount frame/fork to post mount caliper



CP2019046
Ø140 front

CP2019047
Ø140 rear

CP2019048
Ø160 front

CP2019045
Ø160 rear

FM - FM CALIPER ADAPTERS

Flat mount frame/fork to flat mount caliper



CP2019044
Ø140 front
Ø160 front

CP2017160
Ø160 rear

BRAKE

- Rim brake pads
- Disc brake pads
- Disc brake rotors
- Caliper adapters
- Caliper bolts
- Disc brake parts
- Disc brake systems

CABLE

- Superflex cables
- Inner cables
- Outer cables
- Cable kits
- Cable parts

HYDRO

- Extending & repairing
- Original brands
- Hydro components
- O-rings

ROTATION

- Bearings
- Headset bearings
- Headset parts
- Pulley wheels
- Bottom bracket guide
- Bottom brackets
- Bottom bracket parts

TOOLS & MAINTENANCE

- Maintenance
- Cable tools
- Hydro tools
- More tools
- Bottom bracket tools

WORKSHOP

- Transit
- Boxer
- Partner
- Caddy
- Padfinder
- Discovery
- Bleed station

FLATMOUNT BOLTS FOR SHIMANO



2022052
2 pcs
 M5 x 23 mm



2022053
2 pcs
 M5 x 28 mm



2022054
2 pcs
 M5 x 33 mm



2022055
2 pcs
 M5 x 38 mm



2022056
2 pcs
 M5 x 43 mm



2022057
2 pcs
 M5 x 48 mm

FLATMOUNT BOLTS



2021113
2 pcs
 M5 x 23 mm



2021114
2 pcs
 M5 x 28 mm



2021115
2 pcs
 M5 x 33 mm



2021116
2 pcs
 M5 x 38 mm



2021117
2 pcs
 M5 x 43 mm



2021118
2 pcs
 M5 x 48 mm



2022021
2 pcs
 FM adapter bolts
 M5 x 8 mm



2022020
2 pcs
 PM bolts
 M6 x 20 mm



2022019
1 set
 PM bolts
 M6 x 35 mm
 M6 x 40 mm

ROTOR ACCESSORIES



CP2012048
1 pce
 CNC Centra-lock
 Adapter with lock ring
 Aluminium



2021068
1 pce
 CNC Centra-lock
 Lock ring
 Aluminium



2023012
4 pcs
 Centra-lock shim
 0.1 mm
 Stainless steel



2023013
4 pcs
 Centra-lock shim
 0.2 mm
 Stainless steel



2019068
8 pcs
 0.1 mm
 Rotor shim
 Stainless steel



2019054
8 pcs
 0.2 mm
 Rotor shim
 Stainless steel



2017149
1 pce
 Rotor shim
 1 mm
 Stainless steel



2023077
1 set
 Rotor magnet for sensor
 Spare part
 incl. fasteners



CP2015153
6 pcs
 Rotor bolt
 Torx head
 Titanium CNC



2017187 **12 pcs**
ELV2015157 **100 pcs**
 Rotor bolt
 Torx head
 Stainless steel

PINS & CLIPS



2017178
10 pcs
 Set screw
 Magura Marta,
 Gustava, Louise
 2007
 M4 x 22.5



2017179
10 pcs
 Fixing pin
 Shimano Deore,
 Avid Elixir 1/3
 35 mm



2017180
10 pcs
 Fixing pin
 Hayes, Hope
 45 mm



2017181
10 pcs
 Fixing bolt
 Avid Elixir 5/7/9,
 Guide, Code, Trail
 M4 x 22



2017182
10 pcs
 Fixing pin
 Shimano XT, XTR,
 Magura MT 2/4/6/8,
 Tektro, Formula Oro
 M4 x 27



2017183
10 pcs
 Fixing pin
 Hayes Ryde,
 Dyno
 M4 x 36



2017184
10 pcs
 Fixing bolt
 Formula Mega,
 Hope E4/V4/
 X2/V2
 M5 x 25



2020247
10 pcs
 Clip
 M4 / M5



2020248
10 pcs
 Clip
 SRAM

BRAKE

- Rim brake pads
- Disc brake pads
- Disc brake rotors
- Caliper adapters
- Caliper bolts

Disc brake parts

Disc brake systems

CABLE

- Superflex cables
- Inner cables
- Outer cables
- Cable kits
- Cable parts

HYDRO

- Extending & repairing
- Original brands
- Hydro components
- O-rings

ROTATION

- Bearings
- Headset bearings
- Headset parts
- Pulley wheels
- Bottom bracket guide
- Bottom brackets
- Bottom bracket parts

TOOLS & MAINTENANCE

- Maintenance
- Cable tools
- Hydro tools
- More tools
- Bottom bracket tools

WORKSHOP

- Transit
- Boxer
- Partner
- Caddy
- Padfinder
- Discovery
- Bleed station



MP1000 MECHANICAL DISC BRAKE CALIPER

Post mount

2017130

1 pce

Dual piston disc brake caliper

For optimal performance, use with:

2010016 outer cable

1160 CNC ferrules

1.8 – 1.9 mm rotor thickness

Replacement disc brake pads: 6894 model



MP1000 MECHANICAL DISC BRAKE CALIPER

Flat mount

2019097

1 pce

Dual piston disc brake caliper

For optimal performance, use with:

2010016 outer cable

1160 CNC ferrules

1.8 – 1.9 mm rotor thickness

Replacement disc brake pads: 6907 model



LEFT

RIGHT

MP1000 MECHANICAL DISC BRAKE CALIPER

Post mount TWIN

2019098

1 pair (left + right)

Dual piston disc brake caliper

For optimal performance, use with:

2010016 outer cable

1160 CNC ferrules

1.8 – 1.9 mm rotor thickness

Replacement disc brake pads: 6894 model



MECHANICAL DISC BRAKE LEVER

2.5 - 3 finger

Ø23 mm

2017131

Left + right hand **1 pair**

2018054

Left hand **1 pce**

2018055

Right hand **1 pce**



DUAL BRAKE LEVER WITH PARKING STOP

3 finger

Ø23 mm

2010015

Right hand **1 pce**

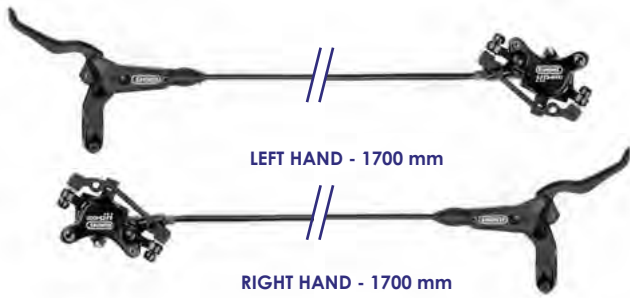

HP4000 HYDRAULIC DISC BRAKE SET

2017132

Mineral oil system

2.5 - 3 finger lever

Dual piston disc brake caliper

Replacement disc brake pads for

HP4000: 6890 model

Replacement Ø160 mm rotor: 2018053

Spare hose fitting set for HP4000: CP2020139

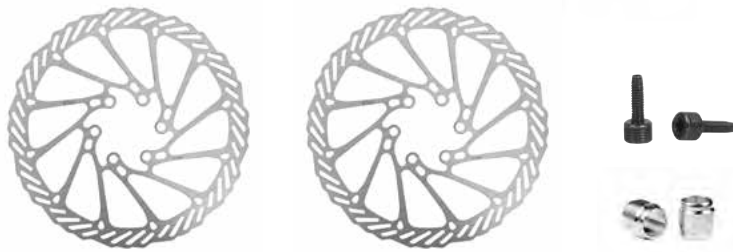

HP4000 HYDRAULIC DISC BRAKE SET LEFT HAND

2018108



HP4000 HYDRAULIC DISC BRAKE SET RIGHT HAND

2018107



HP4000 BLEED BLOCK

2022081

How to bleed the
HP4000 system



BRAKE

Rim brake pads

Disc brake pads

Disc brake rotors

Caliper adapters

Caliper bolts

Disc brake parts

Disc brake systems

CABLE

Superflex cables

Inner cables

Outer cables

Cable kits

Cable parts

HYDRO

Extending & repairing

Original brands

Hydro components

O-rings

ROTATION

Bearings

Headset bearings

Headset parts

Pulley wheels

Bottom bracket guide

Bottom brackets

Bottom bracket parts

TOOLS & MAINTENANCE

Maintenance

Cable tools

Hydro tools

More tools

Bottom bracket tools

WORKSHOP

Transit

Boxer

Partner

Caddy

Padfinder

Discovery

Bleed station

CABLE 2



SUPERFLEX OUTER CABLES

Flexible, small diameter outer cables are ideal for internal cable guiding and easily cornering all kinds of angles. Excellent for dropper-posts, lock-out remotes and shift systems.



BRAKE

- Rim brake pads
- Disc brake pads
- Disc brake rotors
- Caliper adapters
- Caliper bolts
- Disc brake parts
- Disc brake systems

CABLE

- Superflex cables
- Inner cables
- Outer cables
- Cable kits
- Cable parts

HYDRO

- Extending & repairing
- Original brands
- Hydro components
- O-rings

ROTATION

- Bearings
- Headset bearings
- Headset parts
- Pulley wheels
- Bottom bracket guide
- Bottom brackets
- Bottom bracket parts

TOOLS & MAINTENANCE

- Maintenance
- Cable tools
- Hydro tools
- More tools
- Bottom bracket tools

WORKSHOP

- Transit
- Boxer
- Partner
- Caddy
- Padfinder
- Discovery
- Bleed station



VOLUME BOX
2022018
 Ø3.5 mm for dropper/
 remote
 Black
 Box 30 m
 For Ø1.1 mm inner
 cable



A



FERRULES
ELV2021080
50 pcs
 Ø3.65 to Ø5.5
 Aluminium



FERRULES
ELV2024015
50 pcs
 Ø3.65 to Ø4.05
 Aluminium



VOLUME BOX
2023090-BOX
 Ø3.2 mm for internal
 shifting
 Black
 Box 30 m
 For Ø0.9 mm inner
 cable



C



FERRULES
ELV2023092
50 pcs
 Ø3.4 to Ø5.7
 Aluminium



FERRULES
ELV2023100
50 pcs
 Ø3.4 to Ø4.05
 Aluminium



SUPERFLEX INNER CABLES

Flexible, extra smooth inner cables (types D and E) are ideal for easily running through an outer cable with difficult angles. 0.9 mm micro flex inner cables are excellent for internal cable guiding.

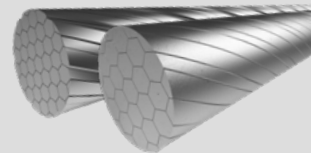

VOLUME BOX

 <p>Ø1.1</p>	 <p>Ø4</p> <p>4</p>	⊕ 6472RVS-49-SLICK-BOX	S	2 250 mm	D	50 pcs
		⊕ 2021056-BOX	S	2 250 mm	E	50 pcs
 <p>Ø0.9</p>	 <p>Ø4</p> <p>4</p>	⊕ 2023091-BOX	S	2 500 mm	A	50 pcs

CARD

 <p>Ø1.1</p>	 <p>Ø4</p> <p>4</p>	⊕ 6472RVS-49-SLICK	S	2 250 mm	D	20 pcs/carton
		⊕ 2020213	S	4 000 mm	D	15 pcs/carton
		⊕ 2021056	S	2 250 mm	E	20 pcs/carton
		⊕ 2021057	S	4 000 mm	E	15 pcs/carton
 <p>Ø0.9</p>	 <p>Ø4</p> <p>4</p>	⊕ 2023091	S	2 500 mm	A	20 pcs/carton

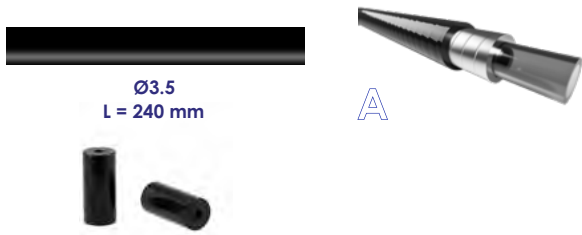

SHIFT OT-RS900

2021074
2021073

Black
Black

10 pcs/bag, 15 bags/carton
1 pce/bag, 15 bags/carton

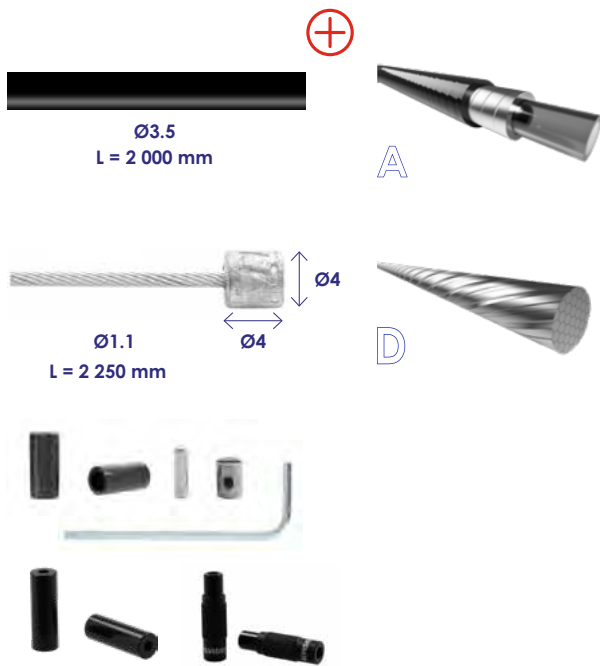

CABLE KIT DROPPER-POST AND LOCK-OUT REMOTES (excl. remote)

2024105



CABLE KIT MICRO FLEX FOR 1X SHIFT

2023089

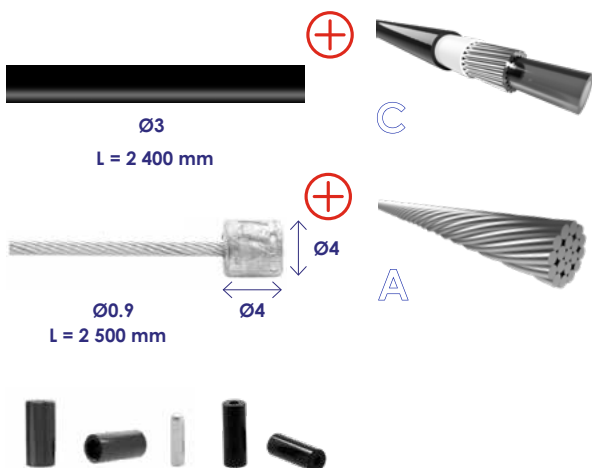

VOLUME BOX

The easy pull system ensures the inner cables can be easily taken out of the box without getting tangled.



BRAKE

- Rim brake pads
- Disc brake pads
- Disc brake rotors
- Caliper adapters
- Caliper bolts
- Disc brake parts
- Disc brake systems

CABLE

- Superflex cables
- Inner cables
- Outer cables
- Cable kits
- Cable parts

HYDRO

- Extending & repairing
- Original brands
- Hydro components
- O-rings

ROTATION

- Bearings
- Headset bearings
- Headset parts
- Pulley wheels
- Bottom bracket guide
- Bottom brackets
- Bottom bracket parts

TOOLS & MAINTENANCE

- Maintenance
- Cable tools
- Hydro tools
- More tools
- Bottom bracket tools

WORKSHOP

- Transit
- Boxer
- Partner
- Caddy
- Padfinder
- Discovery
- Bleed station



19 stands - Regular



A

19 strands slick - Extra smooth



B

49 (7x7) strands - Extra flexible



C

49 (7x7) strands slick - Extra flexible, extra smooth



D

31 strands slick - Medium flexible, extra smooth



E



INNER CABLES

Flexible, extra smooth inner cables (D,E) are ideal for easily running through an outer cable with a lot of bends.

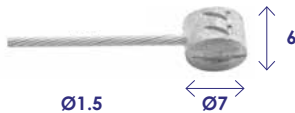
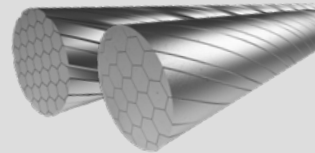

BRAKE

6426RVS-BOX	S	2 000 mm	A	100 pcs
6426RVS-SLICK-BOX	S	2 000 mm	B	100 pcs
6427RVS-BOX	S	2 250 mm	A	100 pcs
6427RVS-SLICK-BOX	S	2 250 mm	B	100 pcs
6427RVS-49-BOX	S	2 250 mm	C	100 pcs
6427RVS-3M-BOX	S	3 000 mm	A	50 pcs

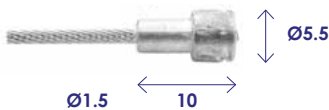

BRAKE

6411RVS-BOX	S	2 000 mm	A	100 pcs
6411RVS-SLICK-BOX	S	2 000 mm	B	100 pcs
6411RVS-49-BOX	S	2 000 mm	C	100 pcs

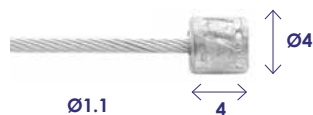

SHIFT

6472RVS-BOX	S	2 250 mm	A	100 pcs
6472RVS-SLICK-BOX	S	2 250 mm	B	100 pcs
6472RVS-49-BOX	S	2 250 mm	A	100 pcs
⊕ 6472RVS-49-SLICK-BOX	S	2 250 mm	D	50 pcs
6472RVS-3M-BOX	S	3 000 mm	A	50 pcs
2021056-BOX	S	2 250 mm	A	50 pcs

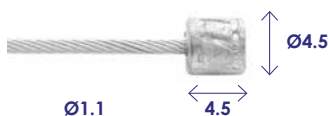

SHIFT

Only compatible with Shimano and SRAM

6472RVS-SHIM-BOX	S	2 250 mm	A	100 pcs
6472RVS-SHIM-SL-BOX	S	2 250 mm	B	100 pcs
⊕ 6472RVS-SH-49-SL-BOX	S	2 250 mm	D	50 pcs



CARD

Types of inner cables

G - Galvanised

S - Stainless steel

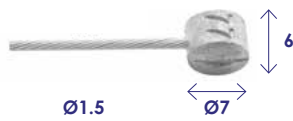

BRAKE

6414	G 900 mm	A	20 pcs
6414RVS	S 1 000 mm	A	20 pcs
6416RVS	S 1 250 mm	A	20 pcs
6426	G 2 000 mm	A	20 pcs
6426RVS	S 2 000 mm	A	20 pcs
6426RVS-SLICK	S 2 000 mm	B	20 pcs
6427	G 2 000 mm	A	20 pcs
6427RVS	S 2 250 mm	A	20 pcs
6427RVS-SLICK	S 2 250 mm	B	20 pcs
6427RVS-49	S 2 250 mm	C	20 pcs
6414RVS	S 2 250 mm	A	20 pcs
6427-3M	G 3 000 mm	A	15 pcs
6427RVS-3M	S 3 000 mm	A	15 pcs
6427RVS-5M	S 5 000 mm	A	10 pcs

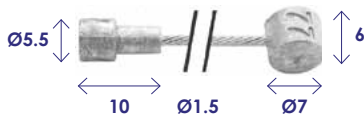

BRAKE

6412/27	G 2 250 mm	A	20 pcs
6412/27RVS	S 2 350 mm	A	20 pcs
6412/27RVS-SLICK	S 2 350 mm	B	20 pcs
6412/27RVS-49	S 2 250 mm	C	20 pcs
6412/27RVS-3M	S 3 000 mm	A	15 pcs
6412/27-4M	G 4 000 mm	A	10 pcs
6412/27RVS-4M	S 4 000 mm	A	10 pcs

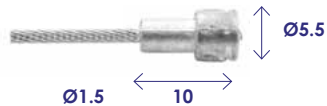

BRAKE

6411	G 2 000 mm	A	20 pcs
6411RVS	S 2 000 mm	A	20 pcs
6411RVS-SLICK	S 2 000 mm	B	20 pcs
6412	G 2 250 mm	A	20 pcs
6412RVS	S 2 250 mm	A	20 pcs
6412RVS-SLICK	S 2 250 mm	B	20 pcs
6412RVS-49	S 2 250 mm	C	20 pcs

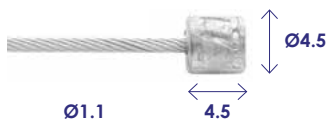

SHIFT

Only compatible with Shimano and SRAM

6472RVS-SHIM	S 2 250 mm	A	20 pcs
6472RVS-SHIM-SLICK	S 2 250 mm	B	20 pcs
⊕ 6472RVS-SHIM-49-SL	S 2 250 mm	D	20 pcs
⊕ 2020213	S 4 000 mm	D	15 pcs

19 strands - Regular



19 strands slick - Extra smooth



49 (7x7) strands - Extra flexible



49 (7x7) strands slick - Extra flexible, extra smooth



31 strands slick - Medium flexible, extra smooth

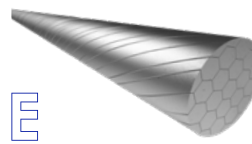

SHIFT

6446
6446RVS

G 2 250 mm A 20 pcs
S 2 250 mm A 20 pcs



SHIFT

6400
6400RVS
6400RVS-3M

G 2 250 mm A 20 pcs
S 2 250 mm A 20 pcs
S 3 000 mm A 20 pcs

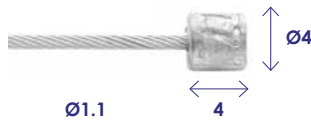

SHIFT

6446-1
6472RVS
6472RVS-SLICK
6472RVS-3M
6472RVS-49
⊕ 6472RVS-49-SLICK
6472RVS-4M
6472RVS-5M
⊕ 2021056
⊕ 2021057

G 2 250 mm A 20 pcs
S 2 250 mm A 20 pcs
S 2 250 mm B 20 pcs
S 3 000 mm A 20 pcs
S 2 250 mm C 20 pcs
S 2 250 mm D 20 pcs
S 4 000 mm A 15 pcs
S 5 000 mm A 15 pcs
S 2 250 mm E 20 pcs
S 4 000 mm E 15 pcs

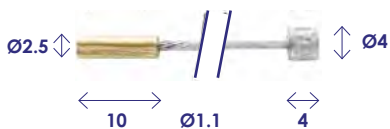

SHIFT

6451/72RVS
6451/72RVS-3M

S 2 250 mm A 20 pcs
S 3 000 mm A 20 pcs

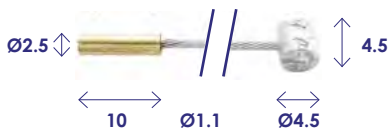

SHIFT

6451/18

G 2 250 mm A 20 pcs



CANTILEVER

2020105

S 400 mm C 20 pcs/carton

BRAKE

- Rim brake pads
- Disc brake pads
- Disc brake rotors
- Caliper adapters
- Caliper bolts
- Disc brake parts
- Disc brake systems

CABLE

- Superflex cables
- Inner cables
- Outer cables
- Cable kits
- Cable parts

HYDRO

- Extending & repairing
- Original brands
- Hydro components
- O-rings

ROTATION

- Bearings
- Headset bearings
- Headset parts
- Pulley wheels
- Bottom bracket guide
- Bottom brackets
- Bottom bracket parts

TOOLS & MAINTENANCE

- Maintenance
- Cable tools
- Hydro tools
- More tools
- Bottom bracket tools

WORKSHOP

- Transit
- Boxer
- Partner
- Caddy
- Padfinder
- Discovery
- Bleed station

VOLUME BOX

All Elvedes outer cables have MoS2 enriched liner for lower friction and higher performance.

The outer cable volume boxes come with an easy pull reel made of 100% recycled and 100% recyclable plastic.

The boxes are also equipped with a unique GripClip, which prevents the outer cable from slipping back into the box after cutting.



The cable type is indicated by the letter A, B, C or D

Brake cable



A

Braided brake cable



B

Shift cable



C

Braided shift / brake cable



D

SHIFT

Ø4.1 - Box 30 m

1120SP-1-BOX	C		Black
1120SP-3-BOX	C		Silver
1120SP-6-BOX	C		White

SHIFT

Ø4.1 - Bag 10 m

1120SP-1-10	C		Black
1120SP-3-10	C		Silver
1120SP-6-10	C		White
1120SP-7-10	C		Red
1120SP-8-10	C		Blue
1120SP-9-10	C		Orange
1120SP-10-10	C		Green
1120SP-11-10	C		Neon orange
1120SP-12-10	C		Neon yellow
1120SP-13-10	C		Neon green
1120SP-14-10	C		Yellow
1120SP-15-10	C		Pink
2019089-10	C		Brown
2019091-10	C		Celeste

SHIFT

Ø4.9 - Box 30 m

1125SP-1-BOX	C		Black
1125SP-3-BOX	C		Silver

SHIFT

Ø4.9 - Bag 10 m

1125SP-1-10	C		Black
1125SP-3-10	C		Silver
182041-10	D		Silver
182042-10	D		Smoke silver
182043-10	D		Titanium

REINFORCED BRAKE AND SHIFT

Ø4.9 - Box 30 m

⊕ 2010016-BOX	D		Carbon
---------------	---	--	--------

BRAKE

Ø4.9 - Box 30 m

1125-BOX	-		Black
1125TEF-1-BOX	A		Black
1125TEF-2-BOX	A		Grey
1125TEF-3-BOX	A		Silver
1125TEF-6-BOX	A		White

BRAKE

Ø4.9 - Bag 10 m

1125-10	A		Black
1125TEF-1-10	A		Black
1125TEF-2-10	A		Grey
1125TEF-3-10	A		Silver
1125TEF-6-10	A		White
1125TEF-7-10	A		Red
1125TEF-8-10	A		Blue
1125TEF-9-10	A		Orange
1125TEF-10-10	A		Green
1125TEF-11-10	A		Neon orange
1125TEF-12-10	A		Neon yellow
1125TEF-13-10	A		Neon green
1125TEF-14-10	A		Yellow
1125TEF-15-10	A		Pink
2019088-10	A		Brown
2019090-10	A		Celeste
1125LSR-6-10	A		Black/chrome
1125LSR-7-10	A		Chrome
182038-10	B		Silver
182039-10	B		Smoke silver
182040-10	B		Titanium

REINFORCED BRAKE AND SHIFT

Ø4.9 - Bag 10 m

⊕ 2010016-10	D		Carbon
--------------	---	--	--------



Linear outer cable for powerful braking and precise shifting. Excellent for cargo bikes, tandems and mechanical disc brakes.



19 strands - Regular

49 (7x7) strands slick - Extra flexible, extra smooth



BRAKE

- Rim brake pads
- Disc brake pads
- Disc brake rotors
- Caliper adapters
- Caliper bolts
- Disc brake parts
- Disc brake systems

CABLE

- Superflex cables
- Inner cables
- Outer cables
- Cable kits

Cable parts

HYDRO

- Extending & repairing
- Original brands
- Hydro components
- O-rings

ROTATION

- Bearings
- Headset bearings
- Headset parts
- Pulley wheels
- Bottom bracket guide
- Bottom brackets
- Bottom bracket parts

TOOLS & MAINTENANCE

- Maintenance
- Cable tools
- Hydro tools
- More tools
- Bottom bracket tools

WORKSHOP

- Transit
- Boxer
- Partner
- Caddy
- Padfinder
- Discovery
- Bleed station



BRAKE CABLE KIT
Fits MTB and road systems

2015009 A Black



SHIFT CABLE KIT
Fits MTB and road systems

2015002 A Black



1X SHIFT CABLE KIT
Fits MTB and road systems

2021040 D Black



FREESTYLE CABLE UPPER

6484 1 pce



FREESTYLE CABLE LOWER

6489 1 pce

UNIVERSAL CABLE SPLITTER SET

Operates 2 brakes with 1 brake lever.
Includes a unique part (D) to add an optional ABS function.
Easy and quick assembly.



Scan this code for instructions

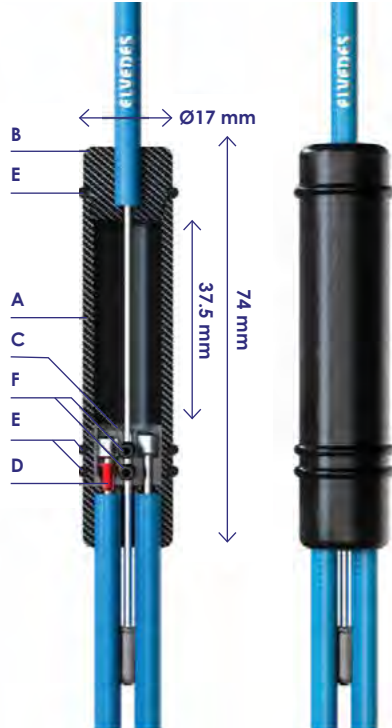

2017161

Inner cables included.
Ø4.9 mm outer cables not included.

- | | |
|---------------------|-------------------------|
| A Body | E O-ring |
| B Cap | F M3 fixing bolt |
| C Piston | G Allen key |
| D ABS insert | |

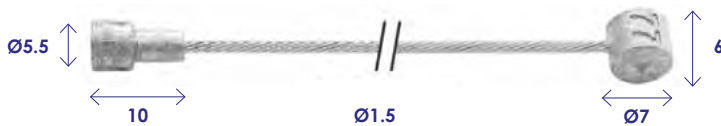

1x 19 strands - Regular



REPLACEMENT INNER CABLE (UPPER) for universal cable splitter

6412/27RVS/1.35 Stainless 1 350 mm **20 pcs/carton**

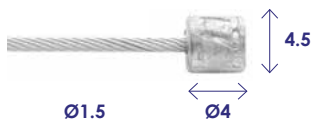

49 (7x7) strands -
Extra flexible



REPLACEMENT INNER CABLE (LOWER) for universal cable splitter

2017145 Stainless 3 000 mm **15 pcs/carton**



CARD

All cable kits are available per card.
Cards per carton are mentioned per item no.

Types of inner cables

- G** - Galvanised
- S** - Stainless steel



BRAKE

2021071

1 800 mm Ø4.9 Black **15 pcs/carton**



SHIFT

2021072

2 000 mm Ø4.1 Black **15 pcs/carton**



DRUMBRAKE

6473

G 2 250 mm

14 pcs/carton

6473RVS

S 2 350 mm

14 pcs/carton



DRUMBRAKE

6269SP

G 1 800 mm 2 250 mm

Black **15 pcs/carton**

6269SP-RVS

S 1 800 mm 2 350 mm

Black **15 pcs/carton**

6269SP-3

S 1 800 mm 2 350 mm

Silver **15 pcs/carton**



BRAKE UNIVERSAL

6445RVS

S 1 800 mm 2 350 mm

Black **15 pcs/carton**

6445-3

S 1 800 mm 2 350 mm

Silver **15 pcs/carton**



BRAKE 2 NIPPLES

6444/39

G 1 800 mm 2 250 mm

Black **15 pcs/carton**

BRAKE

- Rim brake pads
- Disc brake pads
- Disc brake rotors
- Caliper adapters
- Caliper bolts
- Disc brake parts
- Disc brake systems

CABLE

- Superflex cables
- Inner cables
- Outer cables
- Cable kits
- Cable parts

HYDRO

- Extending & repairing
- Original brands
- Hydro components
- O-rings

ROTATION

- Bearings
- Headset bearings
- Headset parts
- Pulley wheels
- Bottom bracket guide
- Bottom brackets
- Bottom bracket parts

TOOLS & MAINTENANCE

- Maintenance
- Cable tools
- Hydro tools
- More tools
- Bottom bracket tools

WORKSHOP

- Transit
- Boxer
- Partner
- Caddy
- Padfinder
- Discovery
- Bleed station



BRAKE

6439

G 1 800 mm 2 000 mm Black 15 pcs/carton



BRAKE

6436

G 540 mm 900 mm Black 15 pcs/carton

6444

G 1 800 mm 2 000 mm Black 15 pcs/carton

6444RVS

S 1 800 mm 2 000 mm Black 15 pcs/carton



SHIFT STURMEY ARCHER UNIVERSAL

6478

G 1 800 mm 2 250 mm Black 15 pcs/carton



NEXUS 4/7/8 SPEED

6286

S 2 000 mm 2 250 mm Black 15 pcs/carton

6287

S 2 000 mm 2 250 mm Silver 15 pcs/carton



SHIFT FOR ALL DERAILLEURS + NEXUS 3 SPEED

6479

S 2 000 mm 2 250 mm Black 15 pcs/carton

6479-3

S 2 000 mm 2 250 mm Silver 15 pcs/carton



SHIFT SRAM UNIVERSAL

6477

G 1 800 mm 2 250 mm Black 15 pcs/carton



ASSORTMENT BOX COLOURED FERRULES AND END CAPS
2012020

Contains:
100 aluminium end caps of each colour
25 aluminium ferrules of each size/colour

ALL PARTS AVAILABLE IN CONSUMER AND WORKSHOP PACKAGING

For consumer packaging: CPxxxx
For workshop packaging: ELVxxxx
Fits Partner display (page 85)



ELV2012001 50 pcs
CP2012001 10 pcs
Ferrule with seal
Ø5 mm brake
Aluminium



CP2012007 10 pcs
Ferrule with seal
Ø4.3 mm shift
Aluminium



ELV1171 500 pcs
CP1171 10 pcs
End cap
Ø2.3 mm
Aluminium



ELV2012002 50 pcs
CP2012002 10 pcs
Ferrule with seal
Ø5 mm brake
Aluminium



ELV2012008 50 pcs
CP2012008 10 pcs
Ferrule with seal
Ø4.3 mm shift
Aluminium



ELV2012013 500 pcs
CP2012013 10 pcs
End cap
Ø2.3 mm
Aluminium



CP2012004 10 pcs
Ferrule with seal
Ø5 mm with brake
Aluminium



CP2012010 10 pcs
Ferrule with seal
Ø4.3 mm shift
Aluminium



CP2012015 10 pcs
End cap
Ø2.3 mm
Aluminium



CP2012003 10 pcs
Ferrule with seal
Ø5 mm with brake
Aluminium



CP2012009 10 pcs
Ferrule with seal
Ø4.3 mm shift
Aluminium



CP2012014 10 pcs
End cap
Ø2.3 mm
Aluminium



CP2012006 10 pcs
Ferrule with seal
Ø5 mm with brake
Aluminium



CP2012012 10 pcs
Ferrule with seal
Ø4.3 mm shift
Aluminium



CP2012017 10 pcs
End cap
Ø2.3 mm
Aluminium



CP2012005 10 pcs
Ferrule with seal
Ø5 mm brake
Aluminium



CP2012011 10 pcs
Ferrule with seal
Ø4.3 mm shift
Aluminium



CP2012016 10 pcs
End cap
Ø2.3 mm
Aluminium

BRAKE

- Rim brake pads
- Disc brake pads
- Disc brake rotors
- Caliper adapters
- Caliper bolts
- Disc brake parts
- Disc brake systems

CABLE

- Superflex cables
- Inner cables
- Outer cables
- Cable kits
- Cable parts

HYDRO

- Extending & repairing
- Original brands
- Hydro components
- O-rings

ROTATION

- Bearings
- Headset bearings
- Headset parts
- Pulley wheels
- Bottom bracket guide
- Bottom brackets
- Bottom bracket parts

TOOLS & MAINTENANCE

- Maintenance
- Cable tools
- Hydro tools
- More tools
- Bottom bracket tools

WORKSHOP

- Transit
- Boxer
- Partner
- Caddy
- Padfinder
- Discovery
- Bleed station



ELV1172 500 pcs
CP1172 10 pcs
 End cap
 Ø1.6 mm
 Aluminium



ELV2018036 25 pcs
 Extension ferrule
 Ø4.3 mm
 Aluminium



ELV2018035 25 pcs
 Extension ferrule
 Ø5 mm
 Aluminium



ELV2023092 50 pcs
 Ferrule
 Ø3.15 mm to Ø5.7
 Aluminium



ELV2021080 50 pcs
 Ferrule
 Ø3.65 mm to Ø5.5
 Aluminium



ELV1130 50 pcs
 Ferrule S.A.
 Ø5 mm
 Brass



ELV2016108 150 pcs
 Ferrule
 Ø4.3 mm to Ø4.75 mm
 Brass



ELV2016107 150 pcs
CP2016107 10 pcs
 Ferrule
 Ø4.3 mm to Ø5.7 mm
 Brass



ELV1001 100 pcs
 Ferrule Weinmann
 Ø5.5 mm
 Aluminium



ELV2015057 100 pcs
 Ferrule with seal
 Ø4.3 mm
 PA6



ELV1160PVC4-1 150 pcs
CP1160PVC4-1 10 pcs
 Ferrule
 Ø4.3 mm
 PA6



ELV1160PVC4-3 150 pcs
 Ferrule
 Ø4.3 mm
 PA6



ELV1160PVC5-1 150 pcs
CP1160PVC5-1 10 pcs
 Ferrule
 Ø5 mm
 PA6



ELV1160PVC5-3 150 pcs
 Ferrule
 Ø5 mm
 PA6



ELV1160 200 pcs
CP1160 10 pcs
 Ferrule CNC
 Ø5 mm
 Brass



ELV1160PRESSED 200 pcs
 Ferrule
 Ø5 mm
 Brass



ELV1167 200 pcs
 Ferrule push fit
 Ø5 mm
 Brass



ELV1178 25 pcs
 Open end cap
 Ø5 mm
 Aluminium



ELV2012107 50 pcs
 Ferrule with tip
 Ø4.3 mm
 PA6



ELV2012106 50 pcs
 Ferrule with tip
 Ø5 mm
 PA6



ELV2023167 15 pcs
 Inline adjuster
 Ø3.5mm
 Aluminium



ELV2014062 15 pcs
Adjuster inline
Ø4.3 mm
Aluminium



ELV2015173 15 pcs
Adjuster inline
Ø5 mm
Aluminium



ELV1073 10 pcs
Adjuster for cable
M6
Brass



ELV1090 25 pcs
Adjuster
M6
Aluminium



ELV1071 50 pcs
Adjuster
M5
Brass



ELV1072 15 pcs
Adjuster
M6
Brass



ELV2020100 15 pcs
Adjuster for lever
M7
Aluminium



ELV2020099 15 pcs
Adjuster for lever
M10
Aluminium



ELV2011003 15 pcs
Adjuster for
rollerbrake
M6
Brass



ELV2015139 15 pcs
CP2015139 2 pcs
Adjuster barrel
Ø4.3 mm
Steel



ELV2015140 15 pcs
CP2015140 2 pcs
Adjuster barrel
Ø4.3 mm
Aluminium



CP2019093 2 pcs
Cable guide
pipe short
Ø5 mm
Aluminium



CP2019094 2 pcs
V-brake pipe 90°
adjustable
Ø5 mm
Stainless steel



CP2019230 2 pcs
V-brake pipe 90°
adjustable, short
Ø5 mm
Stainless steel



ELV2018061 10 pcs
V-brake pipe
90° black
Ø5 mm
Stainless steel



ELV1162-90 10 pcs
V-brake pipe 90°
Ø5 mm
Stainless steel



ELV1162-110 10 pcs
V-brake pipe 110°
Ø5 mm
Stainless steel



ELV1162-130 10 pcs
V-brake pipe 130°
Ø5 mm
Stainless steel



ELV1162 10 pcs
V-brake pipe flex
Ø5 mm
Stainless steel



ELV2012032 10 pcs
CP2012032 1 pce
V-brake pipe flex incl.
rubber boot
Ø5 mm
Stainless steel



CP2017093 2 pcs
V-brake pipe flex,
adjustable
Ø5 mm
Aluminium

BRAKE

Rim brake pads
Disc brake pads
Disc brake rotors
Caliper adapters
Caliper bolts
Disc brake parts
Disc brake systems

CABLE

Superflex cables
Inner cables
Outer cables
Cable kits
Cable parts

HYDRO

Extending & repairing
Original brands
Hydro components
O-rings

ROTATION

Bearings
Headset bearings
Headset parts
Pulley wheels
Bottom bracket guide
Bottom brackets
Bottom bracket parts

TOOLS & MAINTENANCE

Maintenance
Cable tools
Hydro tools
More tools
Bottom bracket tools

WORKSHOP

Transit
Boxer
Partner
Caddy
Padfinder
Discovery
Bleed station



ELV2012111 15 pcs
 Rubber boot
 0.8 - 1.2 mm
 Rubber



ELV1163 15 pcs
 Rubber boot for
 V-brake
 35 mm
 Rubber



ELV2015143 15 pcs
 Rubber boot for
 V-brake
 35 mm
 Rubber



ELV6482/73 10 pcs
 Linkwire
 73 mm
 Steel



ELV6482/82 10 pcs
 Linkwire
 82 mm
 Steel



ELV6482/93 10 pcs
 Linkwire
 93 mm
 Steel



ELV6482/106 10 pcs
 Linkwire
 106 mm
 Steel



ELV2019095 10 pcs
 Cantilever
 cable bolt
 Brass



CP2015144 1 pcs
 Cable hanger for
 cyclo-cross
 Aluminium



ELV2011004 15 pcs
 Cable bolt for Nexus
 4/7/8 speed
 Brass



ELV2011002 15 pcs
 Cable bolt for
 rollerbrake
 BR-IM41/50/53
 Brass



ELV2012024 15 pcs
 Cable bolt for
 rollerbrake
 BR-IM85/81/80/55/45
 Brass



ELV1140 50 pcs
 Cable bolt N-type
 Ø7 mm × 10 mm
 Brass



ELV1144 50 pcs
 Cable bolt N-type
 Ø8 × 14 mm
 Brass



ELV1141 50 pcs
 Cable bolt T-type
 Ø5 × 7 mm
 Brass



ELV1142 50 pcs
 Cable bolt T-type
 Ø6 mm × 14 mm
 Brass



ELV1143 25 pcs
 Cable bolt T-type
 Ø8 mm × 15 mm
 Brass



ELV5050 10 pcs
 Tensioner SRAM T3
 Ø1.5 mm
 PA-GF



ELV9009 10 pcs
 Tensioner drumbrake
 universal
 M4.5
 Brass



ELV4545 15 pcs
 Tensioner S.A. universal
 25 mm
 Brass



ELV2020102 50 pcs
CP2020102 10 pcs
 Cable clip duo
 4.1 + 4.1 mm
 PA6



ELV2020101 50 pcs
CP2020101 10 pcs
 Cable clip duo
 5 mm + 2.5 mm (Di2)
 PA6



ELV2020103 50 pcs
CP2020103 10 pcs
 Cable clip duo
 5 mm + 4.1 mm
 PA6



ELV2020104 50 pcs
CP2020104 10 pcs
 Cable clip duo
 5 + 5 mm
 PA6



ELV2015141 50 pcs
CP2015141 4 pcs
 Cable clip rotating
 Ø4.3 mm - 5 mm



ELV2015142 50 pcs
CP2015142 2 pcs
 Cable clip for frame notch
 Ø5 mm



ELV1174 250 pcs
 O-ring brake/shift
 Ø1.1 - 1.5 mm
 Rubber



ELV2011001 25 pcs
CP2011001 4 pcs
 Frame protector
 Ø4.3 mm - 5 mm
 Rubber



ELV1075 20 pcs
 Cable clip
 Ø5 mm
 PP



SPIRAL WRAP TUBE 10 meter

2018031

Ø4 mm

bundles 3-8 mm

2018032

Ø6 mm

bundles 5-10 mm

2018033

Ø12 mm

bundles 9-65 mm



2018015

ANTI-RATTLE FOAM

Prevents rattling of internal cables and hoses.

Ø11 / 6 mm

L= 750 mm

10 pcs in sealbag



2016116

Cable liner

Ø2.6/2 mm

L= 25 mtr

HDPE

CABLE LINER WITH TRUMPET



2018099

Ø2.5/2 mm

L= 300 mm

HDPE

10 pcs

2018100

Ø2.5/2 mm

L= 1 000 mm

HDPE

10 pcs



2018098 2 pcs

Inner liner brake

Ø2.5/2 mm

L=1 000 mm

HDPE Liner +

ferrule



2018097 2 pcs

Inner liner brake

Ø2/1.4 mm

L=750 mm

HDPE Liner +

ferrule

BRAKE

Rim brake pads

Disc brake pads

Disc brake rotors

Caliper adapters

Caliper bolts

Disc brake parts

Disc brake systems

CABLE

Superflex cables

Inner cables

Outer cables

Cable kits

Cable parts

HYDRO

Extending & repairing

Original brands

Hydro components

O-rings

ROTATION

Bearings

Headset bearings

Headset parts

Pulley wheels

Bottom bracket guide

Bottom brackets

Bottom bracket parts

TOOLS & MAINTENANCE

Maintenance

Cable tools

Hydro tools

More tools

Bottom bracket tools

WORKSHOP

Transit

Boxer

Partner

Caddy

Padfinder

Discovery

Bleed station



HYDRO 3



ORIGINAL BRAND HOSE EXTENSION & REPAIR SET

Extend original brand hydro hoses with fitting sets per brand. Save a lot of time by avoiding internal cable guiding by easily extending your hose to the desired length.



ELV2020240
6 pcs extension nipples
12 pcs compression bolts 5 mm
 Fits any original 5 mm hose
 Use with compatible fittings



ELV2024087
6 pcs extension nipples
12 pcs compression bolts 5.5 mm
 Fits any original 5.5 mm hose
 Use with compatible fittings

Scan QR to learn more



EXTENDING & REPAIRING



2024050
 Shimano BH59



2024051
 Shimano BH90



2024052
 Magura



2024053
 Tektro 5.5



2024054
 Tektro 5.0



2024055
 SRAM



2019105
 Formula



2019106
 Hayes

BRAKE

- Rim brake pads
- Disc brake pads
- Disc brake rotors
- Caliper adapters
- Caliper bolts
- Disc brake parts
- Disc brake systems

CABLE

- Superflex cables
- Inner cables
- Outer cables
- Cable kits
- Cable parts

HYDRO

- Extending & repairing
- Original brands
- Hydro components
- O-rings

ROTATION

- Bearings
- Headset bearings
- Headset parts
- Pulley wheels
- Bottom bracket guide
- Bottom brackets
- Bottom bracket parts

TOOLS & MAINTENANCE

- Maintenance
- Cable tools
- Hydro tools
- More tools
- Bottom bracket tools

WORKSHOP

- Transit
- Boxer
- Partner
- Caddy
- Padfinder
- Discovery
- Bleed station

REPLACEMENT



2020106
Shimano BH90 hose replacement kit with banjo

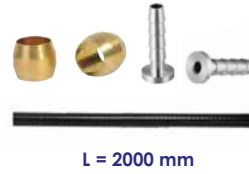

2020107
Shimano BH90 hose replacement kit



2023181
Shimano BH90 hose replacement kit with banjo

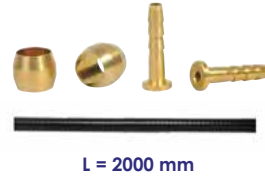

2023079
Shimano BH59 hose replacement kit



2023006
SRAM hose replacement kit with banjo



2023007
SRAM hose replacement kit



2023010
Magura hose replacement kit with banjo



2023011
Magura MT hose replacement kit

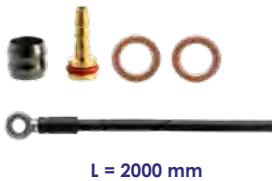

2023008
Tektro 5.0 hose replacement kit with banjo



2023009
Tektro 5.0 hose replacement kit



2023015
Tektro 5.5 hose replacement kit with banjo



2023016
Tektro 5.5 hose replacement kit



2024026
Tektro 5.5 hose replacement kit with banjo



VOLUME BOX

2020138	Brake hose for Shimano BH90	20 m
2021082	Brake hose for Shimano BH59	20 m
2023017	Brake hose for SRAM	20 m
2023018	Brake hose for Tektro 5.0	20 m
2023020	Brake hose for Tektro 5.5	20 m
2023019	Brake hose for Magura MT	20 m



ASSORTMENT BOX ORIGINAL BRAND HOSE FITTINGS 2024123

With this box, any original hose of Tektro, Shimano, Avid, SRAM, Hayes, Formula, Campagnolo and Magura can be shortened.

BRAKE

- Rim brake pads
- Disc brake pads
- Disc brake rotors
- Caliper adapters
- Caliper bolts
- Disc brake parts
- Disc brake systems

CABLE

- Superflex cables
- Inner cables
- Outer cables
- Cable kits
- Cable parts

HYDRO

- Extending & repairing
- Original brands
- Hydro components
- O-rings

ROTATION

- Bearings
- Headset bearings
- Headset parts
- Pulley wheels
- Bottom bracket guide
- Bottom brackets
- Bottom bracket parts

TOOLS & MAINTENANCE

- Maintenance
- Cable tools
- Hydro tools
- More tools
- Bottom bracket tools

WORKSHOP

- Transit
- Boxer
- Partner
- Caddy
- Padfinder
- Discovery
- Bleed station

ELV2024099 30 pcs



Olive SH02
Shimano



ELV2024100 30 pcs

Insert SH03
Shimano BH59



ELV2024101 30 pcs

Insert SH04
Shimano BH90

ELV2024093 30 pcs



Olive AV02-1
SRAM



ELV2024094 30 pcs

Insert AV03-1
SRAM



CP2019116 2 pcs
ELV2019116 10 pcs
Compression bolt
M9 x 1.25
Shimano

ELV2024102 30 pcs



Olive MG02
Magura



ELV2024103 30 pcs

Insert MG03
Magura



CP2017095 2 pcs
ELV2017095 10 pcs
Compression bolt
M9 x 1.25
Magura

ELV2024097 30 pcs



Olive TK04
Tektro 5.0



ELV2024098 30 pcs

Insert TK05
Tektro 5.0



CP2024067 2 pcs
ELV2024067 10 pcs
Compression bolt
M8 x 0.75
5 mm

ELV2024095 30 pcs



Olive TK02
Tektro 5.5



ELV2024096 30 pcs

Insert TK03
Tektro 5.5



CP2024068 2 pcs
ELV2024068 10 pcs
Compression bolt
M8 x 0.75
5.5 mm

ELV-CA02 10 pcs



Olive CA02
Campagnolo



ELV-CA03 10 pcs

Insert CA03
Campagnolo



ELV-HY02 10 pcs

Fitting HY02
Hayes

ELV-FM02 10 pcs



Olive FM02
Formula



ELV-FM03 10 pcs

Insert FM03
Formula



CP2024104 2 pcs
Compression bolt
M8 x 1
Formula

ORIGINAL BRAND HOSE FITTING SET

Shorten 2 original brand hydro hoses with fitting sets per brand.
Packed in a sealbag.



CP2019130
Shimano
SM-BH59



CP2019131
Shimano
SM-BH90



CP2019132
Magura



CP2019133
SRAM



CP2022105
Tektro 5.0



CP2019134
Tektro 5.5



CP2019136
Hayes



CP2020139
Elvedes HP4000



CP2021069
Hope



CP2019135
Formula



CP2023084
Campagnolo

VOLUME BOX

Elvedes hydro hose is reinforced with a braided housing and has a PVDF liner, which makes it suitable for both mineral oil and DOT fluid. The hydro hose volume boxes come with an easy pull reel made of 100% recycled and 100% recyclable plastic. The boxes are also equipped with a unique GripClip, which prevents the hose from slipping back into the box after cutting.



ELVEDES HYDRO HOSE



VOLUME BOX

20 meter hose

Fits Elvedes parts only

Fits Boxer display (page 84)

2012030

Black



ELVEDES HYDRO PARTS



ELV2024069

4 sets

Banjo set 6 mm
for Elvedes Hydro hose only
Stainless steel



ELV2024070

4 sets

M6x1 connector set
for Elvedes Hydro hose only
Stainless steel



ELV2012097

30 pcs

Insert
for Elvedes Hydro
Hose only
Brass



ELV2012098

40 pcs

Olive
for Elvedes Hydro hose only
Brass



CP2019115

2 pcs

Banjo bolt
for Magura
Stainless steel



CP2012104

2 pcs

Banjo bolt
M6x1
Steel



CP2012103

2 pcs

ELV2012103
Banjo bolt
for Shimano
Stainless steel



2017186

10 pcs

Bleed nipple cap

BRAKE

Rim brake pads

Disc brake pads

Disc brake rotors

Caliper adapters

Caliper bolts

Disc brake parts

Disc brake systems

CABLE

Superflex cables

Inner cables

Outer cables

Cable kits

Cable parts

HYDRO

Extending & repairing

Original brands

Hydro components

O-rings

ROTATION

Bearings

Headset bearings

Headset parts

Pulley wheels

Bottom bracket guide

Bottom brackets

Bottom bracket parts

TOOLS & MAINTENANCE

Maintenance

Cable tools

Hydro tools

More tools

Bottom bracket tools

WORKSHOP

Transit

Boxer

Partner

Caddy

Padfinder

Discovery

Bleed station

HYDRO HOSE

Elvedes hydro hose is reinforced with a braided housing and has a PTFE liner, which makes it suitable for both mineral oil and DOT fluid.



ELVEDES HYDRO HOSE

3 metres hose
Suitable for mineral and DOT
Fits Elvedes parts only

2011006	Black	
2011007	White	
2011008	Red	
2011009	Orange	
2011010	Blue	
2011011	Green	

ELVEDES HYDRO PARTS KIT

Stainless steel parts
Combine kits to match the original parts
Fits Elvedes Hydro hose only
1 brake needs 2 kits



2024027	Hydro Parts Kit A: M8×0.75
2024028	Hydro Parts Kit B: Banjo 6 mm
2024029	Hydro Parts Kit C: M6×1
2024030	Hydro Parts Kit D: M9×1.25 (for Magura)
2024031	Hydro Parts Kit E: M9×1.25 (for Shimano)
2024032	Hydro Parts Kit F: M8×1 (for Formula)



ASSORTMENT BOX O-RINGS

2019240

Replacement o-rings for calipers and master cylinders
Blue rings for mineral oil
Black rings for DOT fluid

Contains **20 pieces** of each o-ring



2019241 20 pcs
Shimano R785, XTR
M9000/9020, SLX M7000,
Deore XT M8000/8020,
Alfine S7000



2019242 20 pcs
Shimano Deore, XT, XTR



2019107 20 pcs
Magura MT4/5/6/7/8,
Tektro Orion (SL), Volans,
Auriga (SUB, Tune, Twin),
Dorado, Gemini SL



2019108 20 pcs
Magura MT4



2019109 20 pcs
SRAM Elixir 5, Guide
Ulfimate, HydroR for
flatmount



2019110 20 pcs
SRAM Elixir 7/9, XO
(Trail), XX (World Cup),
HydroR for postmount



2019111 20 pcs
SRAM Elixir 7/9, XO
(Trail), XX (World Cup),
HydroR for postmount
and Formula R1, The
One, Mega



2019112 20 pcs
SRAM Elixir 5 and
Formula The One



2019113 20 pcs
Formula RX



2019114 20 pcs
Hayes Prime, HFX-9,
HFX-MAG

BRAKE

- Rim brake pads
- Disc brake pads
- Disc brake rotors
- Caliper adapters
- Caliper bolts
- Disc brake parts
- Disc brake systems

CABLE

- Superflex cables
- Inner cables
- Outer cables
- Cable kits
- Cable parts

HYDRO

- Extending & repairing
- Original brands
- Hydro components
- O-rings

ROTATION

- Bearings
- Headset bearings
- Headset parts
- Pulley wheels
- Bottom bracket guide
- Bottom brackets
- Bottom bracket parts

TOOLS & MAINTENANCE

- Maintenance
- Cable tools
- Hydro tools
- More tools
- Bottom bracket tools

WORKSHOP

- Transit
- Boxer
- Partner
- Caddy
- Padfinder
- Discovery
- Bleed station



ROTATION 4

INNER DIAMETER	OUTER DIAMETER	WIDTH	TYPE	ITEM NO. INDUSTRIAL BEARING	ITEM NO. MAX BEARING
6	17	6	606		2020052
8	16	5	688	2017105	2020054
8	19	6	698		2020055
8	22	7	608	2017103	2020053
9	20	6	699	2017106	
9	24	7	609	2017104	
10	19	5	6800	2017109	2020059
10	19	7	10197		2020069
10	22	6	6900	2017116	2020062
10	26	8	6000	2017107	2020056
10	28	8	16100	2017195	
12	21	5	6801	2017110	
12	24	6	6901	2017117	2020063
12	28	8	6001	2017108	2020057
15	24	5	6802	2017111	2020060
15	24	7	3802		2021018
15	24	10	3802W		2020066
15	26	7	15267	2017121	2022026
15	26	8	15268	2020070	
15	28	7	6902	2017118	2020064
16	28	7	16287	2023066	
16	31	10	163110	2021051	
17	26	5	6803	2017112	2021049
17	26	7	3803		2021019
17	26	10	3803W		2020067
17	28	6	17286		2020068
17	28	7	17287	2017122	
17	30	7	6903	2017119	2020065
17	35	10	6003		2020058
18	30	7	18307	2018039	
20	32	7	6804	2017113	2024033
20	37	9	6904	2017120	
24	37	7	24377	2017194	2024034
25	37	7	6805	2017114	2020061
30	42	7	6806	2017115	2021050

BRAKE

- Rim brake pads
- Disc brake pads
- Disc brake rotors
- Caliper adapters
- Caliper bolts
- Disc brake parts
- Disc brake systems

CABLE

- Superflex cables
- Inner cables
- Outer cables
- Cable kits
- Cable parts

HYDRO

- Extending & repairing
- Original brands
- Hydro components
- O-rings

ROTATION

- Bearings
- Headset bearings
- Headset parts
- Pulley wheels
- Bottom bracket guide
- Bottom brackets
- Bottom bracket parts

TOOLS & MAINTENANCE

- Maintenance
- Cable tools
- Hydro tools
- More tools
- Bottom bracket tools

WORKSHOP

- Transit
- Boxer
- Partner
- Caddy
- Padfinder
- Discovery
- Bleed station

BEARINGS

All Elvedes bearings are produced complying to ABEC 3. All Elvedes bearings are provided with extra grease for higher durability and performance.



STEEL BEARING BALLS

2021075	1/8"	100 pcs/bag
2021076	5/32"	100 pcs/bag
2021077	3/16"	100 pcs/bag
2021078	1/4"	100 pcs/bag

PACKAGING OPTIONS



XXXXXXX

All bearings can be ordered per piece.



XXXXXXX - BOX20

Selected bearings can be ordered per box, containing 20 pcs.



INDUSTRIAL STEEL BEARINGS

- Balls separated by cage
- For full rotation parts
- ABEC 3

2017103	608 2RS	Ø8 × Ø22 × 7
2017104	609 2RS	Ø9 × Ø24 × 7
2017105	688 2RS	Ø8 × Ø16 × 5
2017106	699 2RS	Ø9 × Ø20 × 6
2017107	6000 2RS	Ø10 × Ø26 × 8
2017108	6001 2RS	Ø12 × Ø28 × 8
2017109	6800 2RS	Ø10 × Ø19 × 5
2017110	6801 2RS	Ø12 × Ø21 × 5
2017111	6802 2RS	Ø15 × Ø24 × 5
2017111-BOX20	6802 2RS	Ø15 × Ø24 × 5
2017112	6803 2RS	Ø17 × Ø26 × 5
2017112-BOX20	6803 2RS	Ø17 × Ø26 × 5
2017113	6804 2RS	Ø20 × Ø32 × 7
2017114	6805 2RS	Ø25 × Ø37 × 7
2017115	6806 2RS	Ø30 × Ø42 × 7

2017116	6900 2RS	Ø10 × Ø22 × 6
2017117	6901 2RS	Ø12 × Ø24 × 6
2017118	6902 2RS	Ø15 × Ø28 × 7
2017118-BOX20	6902 2RS	Ø15 × Ø28 × 7
2017119	6903 2RS	Ø17 × Ø30 × 7
2017119-BOX20	6903 2RS	Ø17 × Ø30 × 7
2017120	6904 2RS	Ø20 × Ø37 × 9
2017121	15267 2RS	Ø15 × Ø26 × 7
2017122	17287 2RS	Ø17 × Ø28 × 7
2017194	24377 2RS	Ø24 × Ø37 × 7
2017195	16100 2RS	Ø10 × Ø28 × 8
2018039	18307 2RS	Ø18 × Ø30 × 7
2018039-BOX20	18307 2RS	Ø18 × Ø30 × 7
2020070	15268 2RS	Ø15 × Ø26 × 8
2021051	163110 2RS	Ø16 × Ø31 × 10
2023066	16287 2RS	Ø16 × Ø28 × 7



MAX STEEL BEARINGS

- Max amount of balls
- For heavy loads
- ABEC 3

2020052	606 2RS MAX	Ø6 × Ø17 × 6
2020053	608 2RS MAX	Ø8 × Ø22 × 7
2020054	688 2RS MAX	Ø8 × Ø16 × 5
2020055	698 2RS MAX	Ø8 × Ø19 × 6
2020056	6000 2RS MAX	Ø10 × Ø26 × 8
2020057	6001 2RS MAX	Ø12 × Ø28 × 8
2020058	6003 2RS MAX	Ø17 × Ø35 × 10
2020059	6800 2RS MAX	Ø10 × Ø19 × 5
2020060	6802 2RS MAX	Ø15 × Ø24 × 5
2020060-BOX20	6802 2RS MAX	Ø15 × Ø24 × 5
2020061	6805 2RS MAX	Ø25 × Ø37 × 7
2020062	6900 2RS MAX	Ø10 × Ø22 × 6
2020063	6901 2RS MAX	Ø12 × Ø24 × 6
2020064	6902 2RS MAX	Ø15 × Ø28 × 7

2020064-BOX20	6902 2RS MAX	Ø15 × Ø28 × 7
2020065	6903 2RS MAX	Ø17 × Ø30 × 7
2020065-BOX20	6903 2RS MAX	Ø17 × Ø30 × 7
2020066	3802W 2RS MAX	Ø15 × Ø24 × 10
2020067	3803W2RS MAX	Ø17 × Ø26 × 10
2020068	17286 2RS MAX	Ø17 × Ø28 × 6
2020069	10197 2RS MAX	Ø10 × Ø19 × 7
2021018	3802 2RS MAX	Ø15 × Ø24 × 7
2021019	3803 2RS MAX	Ø17 × Ø26 × 7
2021049	6803 2RS MAX	Ø17 × Ø26 × 5
2021049-BOX20	6803 2RS MAX	Ø17 × Ø26 × 5
2021050	6806 2RS MAX	Ø30 × Ø42 × 7
2022026	15267 2RS MAX	Ø15 × Ø26 × 7
2024033	6804 2RS MAX	Ø20 × Ø32 × 7
2024034	24377 2RS MAX	Ø24 × Ø37 × 7



ASSORTMENT BOX HEADSET BEARINGS

2019096

Assortment box high precision headset bearings

Contains **2 pcs** of:

2017134	2017140	2019049
2017135	2017141	2019050
2017136	2017142	2019051
2017137	2017143	2019052
2017138	2017246	2019053
2017139	2017247	

Contains **10 pcs** micro spacers

Refill per piece



2017134
MR170
1½"
45° × 45°
Ø40 × Ø52 × 7



2017135
MR122
1⅛"
36° × 45°
Ø30.2 × Ø41 × 6.5



2017136
MR043
1⅛"
36° × 36°
Ø30.15 × Ø41.5 × 6.5



2017137
MR121
1⅛"
45° × 45°
Ø30.5 × Ø41.8 × 8



2017138
MR168
1¼"
45° × 45°
Ø34 × Ø46.8 × 7

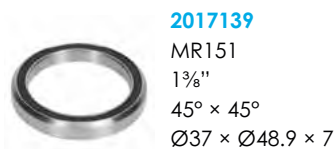

2017139
MR151
1⅜"
45° × 45°
Ø37 × Ø48.9 × 7

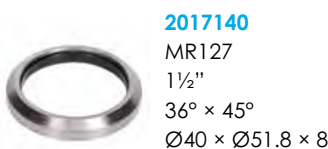

2017140
MR127
1½"
36° × 45°
Ø40 × Ø51.8 × 8



2017141
MR019
1½"
36° × 45°
Ø40 × Ø51.8 × 7.5



2017142
MR006
1½"
36° × 36°
Ø40 × Ø51 × 6.5

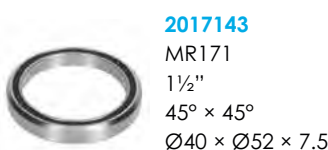

2017143
MR171
1½"
45° × 45°
Ø40 × Ø52 × 7.5

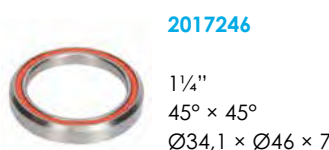

2017246
1¼"
45° × 45°
Ø34,1 × Ø46 × 7

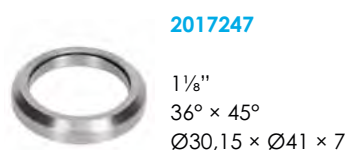

2017247
1⅛"
36° × 45°
Ø30,15 × Ø41 × 7



2019049
MR155
1⅛"
45° × 45°
Ø30.5 × Ø41.8 × 7.5



2019050
MR137
1⅜"
45° × 45°
Ø37 × Ø46.9 × 7

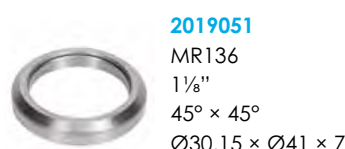

2019051
MR136
1⅛"
45° × 45°
Ø30.15 × Ø41 × 7

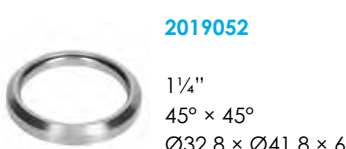

2019052
1¼"
45° × 45°
Ø32.8 × Ø41.8 × 6

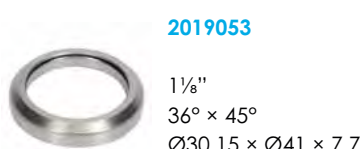

2019053
1⅛"
36° × 45°
Ø30.15 × Ø41 × 7.7



2017144
Micro spacer
for 1⅛"
Ø34.5 mm
0.25 mm

BRAKE

- Rim brake pads
- Disc brake pads
- Disc brake rotors
- Caliper adapters
- Caliper bolts
- Disc brake parts
- Disc brake systems

CABLE

- Superflex cables
- Inner cables
- Outer cables
- Cable kits
- Cable parts

HYDRO

- Extending & repairing
- Original brands
- Hydro components
- O-rings

ROTATION

- Bearings
- Headset bearings

- Headset parts
- Pulley wheels
- Bottom bracket guide
- Bottom brackets
- Bottom bracket parts

TOOLS & MAINTENANCE

- Maintenance
- Cable tools
- Hydro tools
- More tools
- Bottom bracket tools

WORKSHOP

- Transit
- Boxer
- Partner
- Caddy
- Padfinder
- Discovery
- Bleed station

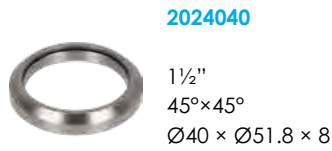
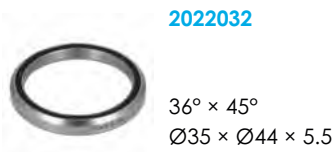
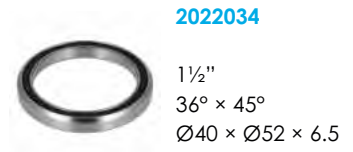
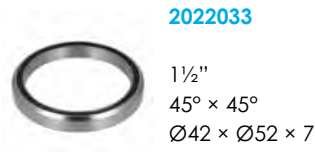
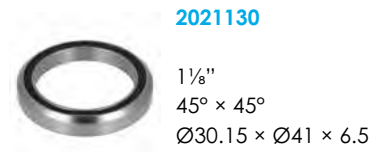
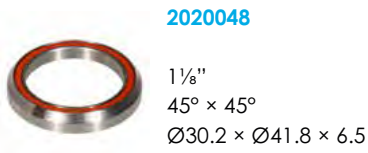

HEADSET BEARING GUIDE

INNER DIAMETER	OUTER DIAMETER	HEIGHT	INNER ANGLE	OUTER ANGLE	INCH	TYPE	ITEM NO.
27.2	38	6.5	36°	45°	1"		2021124
30.15	41	6.5	45°	45°	1 1/8"		2021130
			7	36°	45°	1 1/8"	2017247
		7.7	45°	45°	1 1/8"	2019051	
			36°	45°	1 1/8"	2019053	
		41.5	6.5	36°	45°	1 1/8"	MRO43
30.2	41	6.5	36°	45°	1 1/8"	MR122	2017135
			45°	45°	1 1/8"		2020048
30.5	41.8	7.5	45°	45°	1 1/8"	MR155	2019049
		8	45°	45°	1 1/8"	MR121	2017137
32.8	44	6	36°	45°	1 1/4"		2022029
45°			45°	1 1/4"	MR136	2019052	
45°			45°	1 1/4"	MR168	2017138	
34	46.8	7	45°	45°	1 1/4"		2017246
34.1	46		45°	45°	1 1/4"		2020050
35	44	5		45°	1 3/8"		2020050
		5.5	36°	45°	1 3/8"		2022032
37	46.9	7	45°	45°	1 3/8"	MR137	2019050
	48			45°	1 3/8"		2020051
	48.9	6.5	36°	45°	1 3/8"		2022017
		7	45°	45°	1 3/8"	MR151	2017139
40	51	6.5	36°	45°	1 1/2"	MR006	2017142
		7.5	36°	45°	1 1/2"	MR019	2017141
	51.8	8	36°	45°	1 1/2"	MR127	2017140
		8	45°	45°	1 1/2"		2024040
	52	6.5	36°	45°	1 1/2"		2022034
			45°	45°	1 1/2"		2020049
		7	45°	45°	1 1/2"	MR170	2017134
		7.5	45°	45°	1 1/2"	MR171	2017143
42	52	8	45°	45°	1 1/2"		2023196
		7	45°	45°	1 1/2"		2022033



ASSORTMENT BOX HEADSET PARTS

2020140

Assortment box headset parts
Excludes 2022074 and 2022075



2022074 1 pce
Fork cone for
1 1/8" to 1 1/2"
36° (silver)
Ø30 mm



2022075 1 pce
Fork cone for
1 1/8" to 1 1/2"
45° (black)
Ø30 mm



2020129 1 pce
Fork cone for
1 1/8"
36° (silver)
Ø30 mm



2020130 1 pce
Fork cone for
1 1/8"
45° (black)
Ø30 mm



2020131 1 pce
Fork cone for
1 1/4"
36° (silver)
Ø33 mm



2020132 1 pce
Fork cone for
1 1/4"
45° (black)
Ø33 mm



2020133 1 pce
Fork cone for
1 1/2"
36° (silver)
Ø39.8 mm



2020134 1 pce
Fork cone for
1 1/2"
45° (black)
Ø39.8 mm



2020122 1 pce
Top cover for
1 1/8"
Ø46 mm
8.2 mm



2020123 1 pce
Top cover for
1 1/8"
Ø50 mm
7.2 mm



2020124 1 pce
Top cover for
1 1/8"
Ø55 mm
7.2 mm



2020125 1 pce
Compression ring
for 1 1/8"
36° (silver)
5.8 mm



2020126 1 pce
Compression ring
for 1 1/8"
45° (black)
5.8 mm



2020127 1 pce
Compression ring
for 1 1/8"
36° (silver)
8.4 mm



2020128 1 pce
Compression ring
for 1 1/8"
45° (black)
8.4 mm



2017144-10 10 pcs
Micro spacer for
1 1/8"
Ø34.5 mm
0.25 mm



2020136 5 pcs
Spacer for
1 1/8"
Ø34 mm
2 mm



2020117 1 pce
Top cap assembly
sphere shape
For 1 1/8" metal tube
Incl. bolt, star nut &
rubber sealing cap

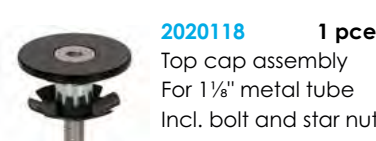

2020118 1 pce
Top cap assembly
For 1 1/8" metal tube
Incl. bolt and star nut



2020119 1 pce
Compression device
23.5 mm
For 1 1/8" carbon tube
Incl. bolt, top cap &
rubber sealing cap



2020120 1 pce
Compression device
26 mm
For 1 1/8" carbon tube
Incl. bolt & top cap



2020121 5 pcs
Standard steel star
nut
For 1 1/8" metal tube

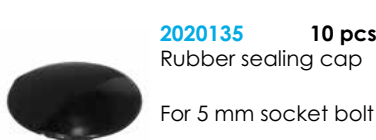

2020135 10 pcs
Rubber sealing cap
For 5 mm socket bolt

BRAKE

- Rim brake pads
- Disc brake pads
- Disc brake rotors
- Caliper adapters
- Caliper bolts
- Disc brake parts
- Disc brake systems

CABLE

- Superflex cables
- Inner cables
- Outer cables
- Cable kits
- Cable parts

HYDRO

- Extending & repairing
- Original brands
- Hydro components
- O-rings

ROTATION

- Bearings
- Headset bearings

Headset parts

- Pulley wheels
- Bottom bracket guide
- Bottom brackets
- Bottom bracket parts

TOOLS & MAINTENANCE

- Maintenance
- Cable tools
- Hydro tools
- More tools
- Bottom bracket tools

WORKSHOP

- Transit
- Boxer
- Partner
- Caddy
- Padfinder
- Discovery
- Bleed station

PULLEY WHEELS

All pulley wheel bearings are produced complying with ABEC 3 or ABEC 5. All pulley wheel bearings are provided with extra grease for higher durability and performance.



2 x 10 TEETH

CP2017231 1 set

ABEC 3 with extra grease
Stainless sealed bearing

Including spacers compatible with:

- A - Shimano 8 speed
- B - Shimano 7 speed, Campagnolo 8 speed
- C - Campagnolo 9 / 10 speed
- D - SRAM (one hole upper pulley) 9.0SL ('98) / 9.0 ('97 - '98) / 7.0 ('97 - '98) / 5.0 ('98 - '99)"



2 x 11 TEETH

CP2017086 1 set

2017086-BOX 10 sets

2017086-BOX25 25 sets

ABEC 3 with extra grease
Stainless sealed bearing

Including spacers compatible with:

- A - Shimano 8 / 9 / 10 / 11 speed & 10 speed GRX
- B - Shimano 7 speed, Campagnolo 8 speed
- C - Campagnolo 9 / 10 speed
- D - SRAM 7.0 / 9.0 ('97 - '99)"



2 x 11 TEETH

CP2023086 1 set

ABEC 3 with extra grease
Stainless sealed bearing
Compatible with Shimano 12 speed



11 + 13 TEETH

2022004 1 set

ABEC 5 with extra grease
Stainless sealed bearing

Compatible with:

- Shimano 11 speed GRX
- RD-RX810-GS**
- RD-RX812-GS**
- RD-RX815-GS**
- RD-RX817-GS**

BRAKE

Rim brake pads
Disc brake pads
Disc brake rotors
Caliper adapters
Caliper bolts
Disc brake parts
Disc brake systems

CABLE

Superflex cables
Inner cables
Outer cables
Cable kits
Cable parts

HYDRO

Extending & repairing
Original brands
Hydro components
O-rings

ROTATION

Bearings
Headset bearings
Headset parts
Pulley wheels

Bottom bracket guide
Bottom brackets
Bottom bracket parts

TOOLS & MAINTENANCE

Maintenance
Cable tools
Hydro tools
More tools
Bottom bracket tools

WORKSHOP

Transit
Boxer
Partner
Caddy
Padfinder
Discovery
Bleed station

2 × 11 TEETH

CP2017100 1 set

ABEC 5 with extra grease
Stainless sealed bearing

Compatible with:
Shimano 9 / 10 / 11 speed & 10 speed GRX
SRAM X0 / X9 / X7 9 speed MTB > 2011
SRAM X0 / X9 / X7 10 speed MTB
SRAM Apex / Rival / Force 10 speed road
(bushing included)
Campagnolo 11 speed



2 × 13 TEETH

CP2019103 1 set

ABEC 5 with extra grease
Stainless sealed bearing

Compatible with:
Shimano RD-M9100 / M8100 / M7100



2 × 12 TEETH

CP2017101 1 set

ABEC 5 with extra grease
Narrow / wide
Stainless sealed bearing

Compatible with:
SRAM X01 / XX1 / X1 GX 1×11 speed
SRAM Rival 1 / Force 1 1×11 speed



12 + 14 TEETH

CP2017102 1 set

ABEC 5 with extra grease
Narrow / wide
Stainless sealed bearing

Compatible with:
SRAM Eagle XX1 / X01 / NX / SX / GX 1×12 speed
and 2×11 speed MTB



2 × 12 TEETH

2020097 1 set

ABEC 5 with extra grease
Narrow / wide
Ceramic hybrid bearing

Compatible with:
SRAM Force / Red eTap AXS



12 + 14 TEETH

2020098 1 set

ABEC 5 with extra grease
Narrow / wide
Ceramic hybrid bearing

Upgrade for:
SRAM Force / Red eTap AXS



GET STARTED

A bottom bracket shell can be threaded or nonthreaded, called thread fit and press fit respectively. It is important to know which type of shell you're working with and what the shell diameter and width are, in order to select a fitting bottom bracket.

The most common thread types in thread fit shells are BSA (English thread), ITA (Italian thread) and T47 (M47×1). A thread type bottom bracket is interlocked directly with the shell. Press fit shells come in various diameters and widths, most commonly PF30 (Ø46 mm), BB30 (Ø42 mm) and BB86/92 (Ø41 mm). Press fit bottom brackets are pressed into the shell using a press-in tool. Another dimension you need to know in order to select a fitting bottom bracket is the spindle diameter. Different brands and models can vary

widely, from Ø30 mm to tapered versions like Praxis (Ø30 mm – Ø28 mm). Differences between brands can also be as little as a few hundreds of millimeters.

Elvedes offers a basic range of bottom brackets, which can be easily adapted to specific types of spindles such as FSA Mega Exo and SRAM / Truvativ GXP using specific bearing caps or reducer kits.

Knowing all three dimensions, the guide on pages 69 - 71 can be used to select the perfectly fitting bottom bracket.

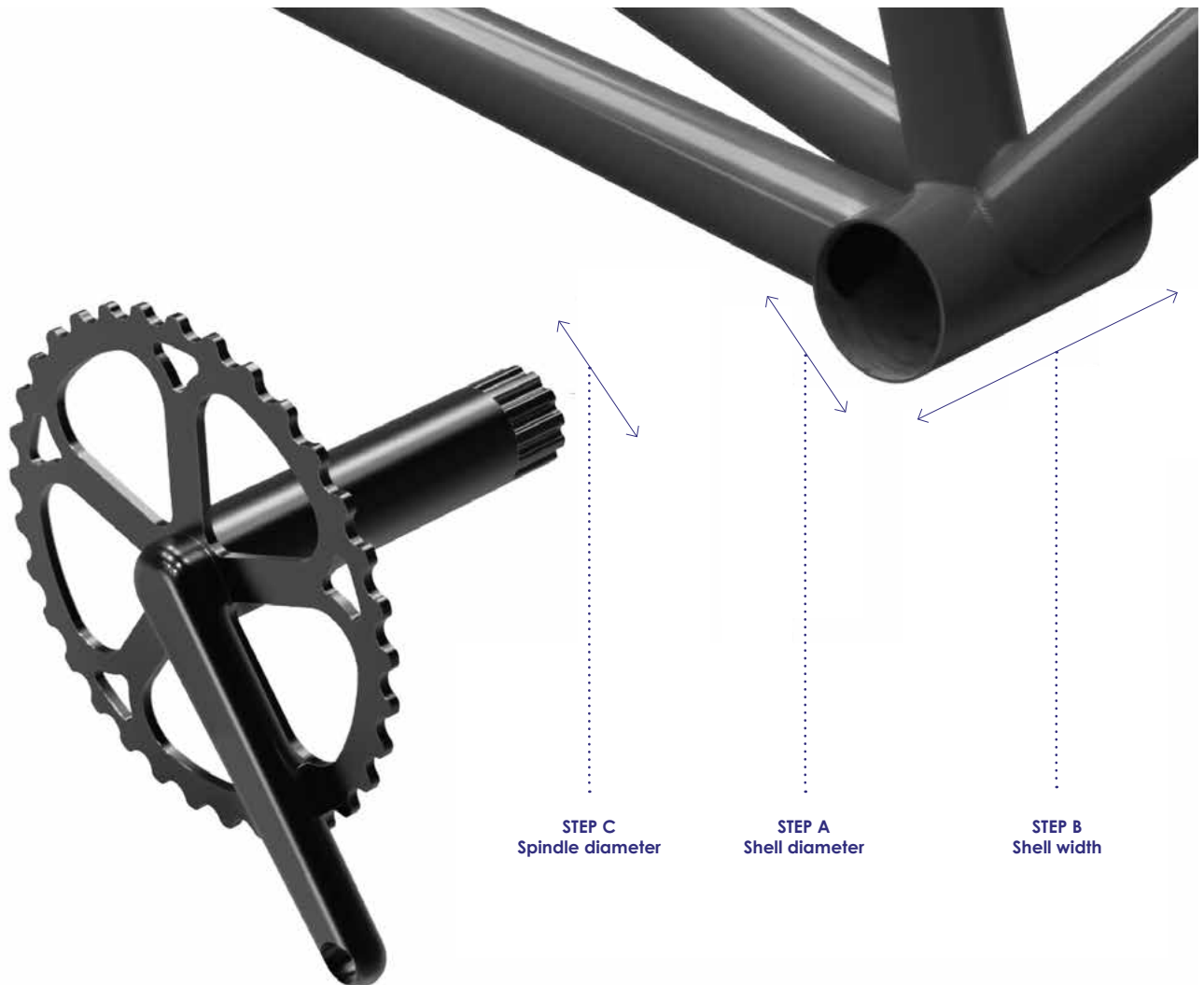

Elvedes also offers an enhanced version of the press fit bottom bracket, called the twist fit bottom bracket (see page 69). The twist fit bottom bracket can alternatively be used in a press fit shell. All bottom bracket bearings are produced complying with ABEC 5.

Replacement bearings and bearing caps are also available for maintenance.

SHIMANO HOLLOWTECH II

GO TO PAGE:			64			68 - 70	72	81	70	72
			A	B	C	Item no.	Add. required	Tool required	Replace. bearings	Replace. bearing caps
Thread fit	BSA	MTB	1.37" × 24 tpi	68 - 73 mm	24 mm	2018066		12T	2019087	2018081
		Road	1.37" × 24 tpi	68 mm	24 mm	2018065		12T	2019087	2018081
		Fatbike	1.37" × 24 tpi	100 mm	24 mm	2019085		12T	2019087	2018081
	ITA	Road	36 mm × 24 tpi	70 mm	24 mm	2018078		12T	2019087	2018081
	T47	External	M47 × 1	68 mm	24 mm	2020093		12T	2019087	2018081
		Internal	M47 × 1	86 mm	24 mm	2020092		12T	2019087	2018081
	T47A		M47 × 1	77.5 mm	24 mm	2024046		12T	2019087	2019066
Press fit	BB86/92		41 mm	86 - 92 mm	24 mm	2018064				2018082
	BB386		46 mm	86mm	24 mm	2021079				2019066
Twist fit	PF30		46 mm	68 -73 mm	24 mm	2018073		16T	2019087	2018082
	BB30		42 mm							
	BB386		46 mm	86 mm	24 mm	2020084		16T	2019087	2018081
	BB86/92		41 mm	86 - 92 mm	24 mm	2018069		16T	2019087	2018082
		Fatbike	41 mm	106 - 132 mm	24 mm	2019084		16T	2019087	2018082
	BB right		46 mm	79 mm	24 mm	2021065		12T + 16T	2019087	2018082 + 2019066

SRAM / TRUVATIV GXP

GO TO PAGE:			64			68 - 70	72	81	70	72
			A	B	C	Item no.	Add. required	Tool required	Replace. bearings	Replace. bearing caps
Thread fit	BSA	MTB	1.37" × 24 tpi	68 - 73 mm	22- 24 mm	2018067			2019087	
			1.37" × 24 tpi			2018066	2018080	12T	2019087	2018081
		Road	1.37" × 24 tpi	68 mm	22- 24 mm	2018065	2018080	12T	2019087	2018081
	Fatbike	1.37" × 24 tpi	100 mm	24 mm	2019085	2018080	12T	2019087	2018081	
	ITA	Road	36 mm × 24 tpi	70 mm	22- 24 mm	2018078	2018080	12T	2019087	2018021
	T47	External	M47 × 1	68 mm	24 mm	2020093	2018080	12T	2019087	2018081
Internal		M47 × 1	86 mm	24 mm	2020092	2018080	12T	2019087	2018081	
	T47A		M47 × 1	77.5 mm	24 mm	2024046	2018080	12T	2019087	2019066
Press fit	BB86/92		41 mm	86 - 92 mm	22- 24 mm	2018064	2018080			2018082
	BB386		46 mm	86mm	24 mm	202179	2018080			2019066
Twist fit	PF30		46 mm	68 -73 mm	22- 24 mm	2018073	2018080	16T	2019087	2018082
	BB30		42 mm							
	BB386		46 mm	86 mm	22- 24 mm	2020084	2018080	16T	2019087	2018082
	BB86/92		41 mm	86 - 92 mm	22- 24 mm	2018069	2018080	16T	2019087	2018082
		Fatbike	41 mm	106 - 132 mm	22- 24 mm	2019084	2018080		2019087	2018082
	BB right		46 mm	79 mm	24 mm	2021065	2018080	12T + 16T	2019087	2018082 + 2019066

SRAM DUB

GO TO PAGE:			64			68 - 70	72	81	70	72
			A	B	C	Item no.	Add. required	Tool required	Replace. bearings	Replace. bearing caps
Thread fit	BSA	MTB	1.37" × 24 tpi	68 - 73 mm	29 mm	2019118		12T	2018077	
	ITA	Road	36 mm × 24 tpi	70 mm	29 mm	2019119		12T	2018077	
	T47	External	M47 × 1	68 mm	29 mm	2020111		12T	2018077	
		Internal	M47 × 1	86 mm	29 mm	2020112		12T	2018077	
	T47A		M47 × 1	77,5 mm	29 mm	2024047		12T	2018077	
Press fit	BB86/92		41 mm	86 - 92 mm	29 mm	2022088				
Twist fit	PF30		46 mm	68 - 73 mm	29 mm	2019120		12T	2018077	
	BB30		42 mm							
	BB386		46 mm	86 mm	29 mm	2019121		12T	2018077	

CAMPAGNOLO ULTRA-TORQUE

GO TO PAGE:			64			68 - 70	72	81	70	72
			A	B	C	Item no.	Add. required	Tool required	Replace. bearings	Replace. bearing caps
Twist fit	PF30		46 mm	68 mm	25 mm	2018074		16T	2019086	
	BB386		46 mm	86 mm	25 mm	2020085		16T	2019086	
	BB86		41 mm	86 mm	25 mm	2018070		16T	2019086	

FSA MEGA EXO 24 MM

GO TO PAGE:			64			68 - 70	72	81	70	72
			A	B	C	Item no.	Add. required	Tool required	Replace. bearings	Replace. bearing caps
Thread fit	BSA	MTB	1.37" × 24 tpi	68 - 73 mm	24 mm	2018066	2018083	12T	2019087	2018083
		Road	1.37" × 24 tpi	68 mm	24 mm	2018065	2018083	12T	2019087	2018083
		Fatbike	1.37" × 24 tpi	100 mm	24 mm	2019085	2019067	12T	2019087	2019067
	ITA	Road	36 mm × 24 tpi	70 mm	24 mm	2018078	2018083	12T	2019087	2018083
	T47	External	M47 × 1	68 mm	24 mm	2020093	2018083	12T	2019087	2018083
		Internal	M47 × 1	86 mm	24 mm	2020092	2018083	12T	2019087	2018083
	T47A		M47 × 1	77,5 mm	24 mm	2024046	2019067	12T	2019087	2019067
Press fit	BB86/92		41 mm	86 - 92 mm	24 mm	2018064	2018084			2018084
	BB386		46 mm	86 mm	24 mm	202179	2019067			2019067
Twist fit	PF30		46 mm	68 - 73 mm	24 mm	2018073	2018083	16T	2019087	2018083
	BB30		42 mm							
	BB386		46 mm	86 mm	24 mm	2020084	2018084	16T	2019087	2018084
	BB86/92		41 mm	86 - 92 mm	24 mm	2018069	2018084	16T	2019087	2018084
Fatbike		41 mm	106 - 132 mm	24 mm	2019084	2018084	16T	2019087	2018084	
	BB right		46 mm	79 mm	24 mm	2021065	2019067 + 2018084	12T + 16T	2019087	2019067 + 2018084

FSA MEGA EXO 19 MM

GO TO PAGE:			64			68 - 70	72	81	70	72
			A	B	C	Item no.	Add. required	Tool required	Replace. bearings	Replace. bearing caps
Thread fit	BSA	MTB	1.37" × 24 tpi	68 - 73 mm	19 mm	2018066	2019064	12T	2019087	2019064
		Road	1.37" × 24 tpi	68 mm	19 mm	2018065	2019064	12T	2019087	2019064
	ITA	Road	36 mm × 24 tpi	70 mm	19 mm	2018078	2019064	12T	2019087	2019064
	T47	External	M47 × 1	68 mm	19 mm	2020093	2019064	12T	2019087	2019064
		Internal	M47 × 1	86 mm	19 mm	2020092	2019064	12T	2019087	2019064
	T47A		M47 × 1	77,5 mm	19 mm	2024046	2019064	12T	2019087	2019064
Press fit	BB86/92		41 mm	86 - 92 mm	19 mm	2018064	2019065			2019065
	BB386		46 mm	86mm	19 mm	2021079	2019064			2019064
Twist fit	PF30		46 mm	68 - 73 mm	19 mm	2018073	2019064	16T	2019087	2019064
	BB30		42 mm					16T	2019087	
	BB386		46 mm	86 mm	19 mm	2020084	2019065	16T	2019087	2019065
	BB86/92		41 mm	86 - 92 mm	19 mm	2018069	2019065	16T	2019087	2019065
		Fatbike	41 mm	106 - 132 mm	19 mm	2019084	2019065	16T	2019087	2019065
	BB right		46 mm	79 mm	19 mm	2021065	2019064 + 2019065	12T + 16T	2019087	2019064 + 2019065

30 MM

GO TO PAGE:			64			68 - 70	72	81	70	72
			A	B	C	Item no.	Add. required	Tool required	Replace. bearings	Replace. bearing caps
Thread fit	BSA	Road	1.37" × 24 tpi	68 mm	30 mm	2018068		12T	2018077	
	ITA	Road	36 mm × 24 tpi	70 mm	30 mm	2018079		12T	2018077	
	T47A		M47 × 1	77,5 mm	30 mm	2024048		12T	2018077	
Press fit	PF30		46 mm	68 mm	30 mm	2019083				
	BB86/92		41 mm	86 - 92 mm	30 mm	2022085				
Twist fit	PF30	Fatbike	46 mm	100 mm	30 mm	2020086		12T	2018077	
			46 mm	68 - 92 mm	30 mm	2018071		12T	2018077	
	BB386/92									

PRAXIS WORKS M30

GO TO PAGE:			64			68 - 70	72	81	70	72
			A	B	C	Item no.	Add. required	Tool required	Replace. bearings	Replace. bearing caps
Thread fit	BSA	Road	1.37" × 24 tpi	68 mm	28 - 30 mm	2020088		12T	2018077	
	ITA	Road	36 mm × 24 tpi	70 mm	28 - 30 mm	2020089		12T	2018077	
	T47		M47 × 1	68 mm	28 - 30 mm	2020115		12T	2018077	
			M47 × 1	86 mm	28 - 30 mm	2020114		12T	2018077	
Press fit	BB86/92		41 mm	86 - 92 mm	28 - 30 mm	2020087				
Twist fit	PF30		46 mm	68 mm	28 - 30 mm	2020090		12T	2018077	
	BB30		42 mm	68 mm						
	BB386		46 mm	86 mm	28 - 30 mm	2020091		12T	2018077	

THREAD FIT

Tool required: 2018086 Bottom bracket wrench
 1 Convertible to GXP with GXP reducer kit (2018080)
 2 Convertible to FSA with FSA bearing caps (page 72)

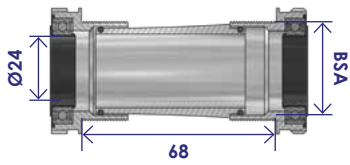

2018065
BSA Shimano Road ^{1 2}

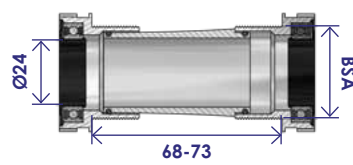

2018066
BSA Shimano MTB ^{1 2}

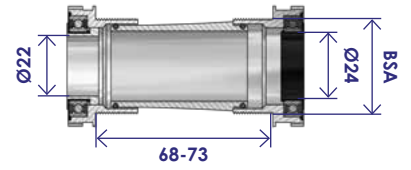

2018067
BSA GXP

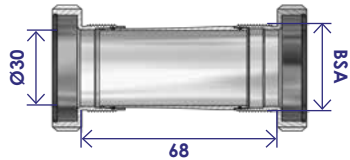

2018068
BSA IB30

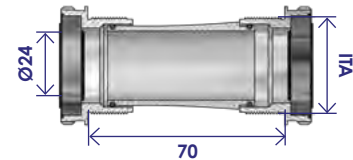

2018078
ITA Shimano Road ^{1 2}

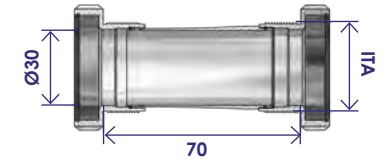

2018079
ITA IB30

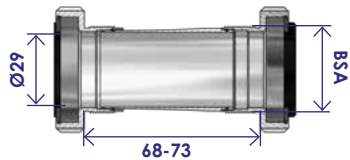

2019118
BSA DUB

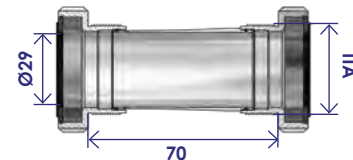

2019119
ITA DUB

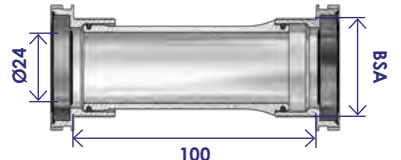

2019085
BSA Shimano Fatbike ^{1 2}

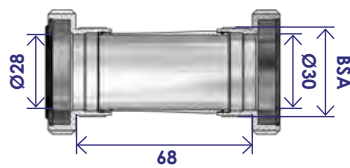

2020088
BSA Praxis

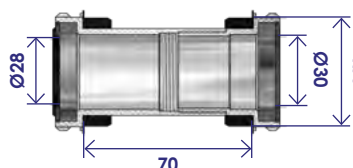

2020089
ITA Praxis

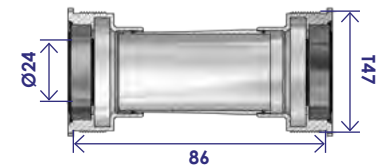

2020092
T47 Shimano Internal ^{1 2}

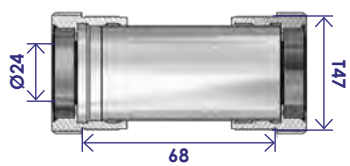

2020093
T47 Shimano External ^{1 2}

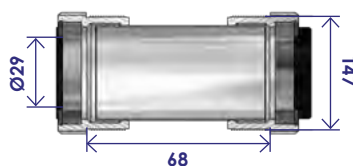

2020111
T47 DUB External

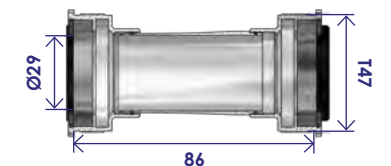

2020112
T47 DUB Internal

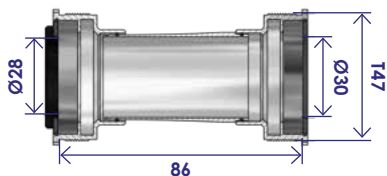

2020114
T47 Praxis Internal

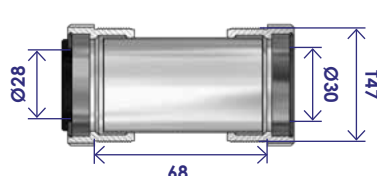

2020115
T47 Praxis External

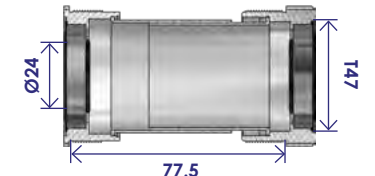

2024046
T47A Shimano

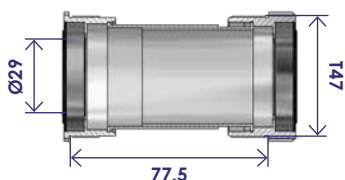

2024047
T47A DUB

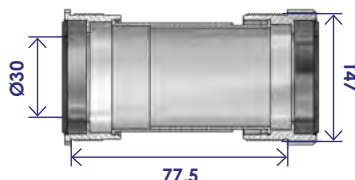

2024048
T47A IB30

TWIST FIT

Tools required: 2018086 Bottom bracket wrench

¹ Convertible to GXP with GXP reducer kit (2018080)

² Convertible to FSA with FSA bearing caps (page 72)

LOW MAINTENANCE COSTS

Only the bearings can be replaced for service maintenance, while the bracket stays in place.

PERFECTLY IN LINE

The threaded interlocking cups allow the spindle to run freely without squeaking and creaking.

EASY INSTALLATION

Elvedes BB wrench required (item no. 2018086)

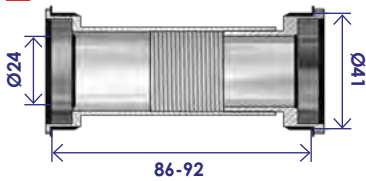

2018069
BB86/92 Shimano^{1 2}

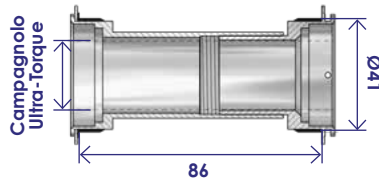

2018070
BB86 UT

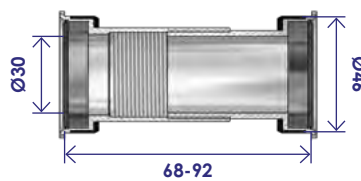

2018071
BB386/92
PF30

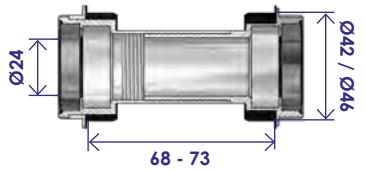

2018073
BB30 Shimano^{1 2}
PF30 Shimano^{1 2}

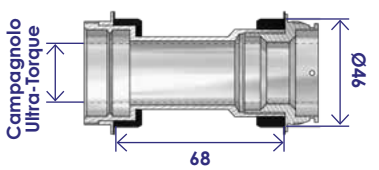

2018074
PF30 UT

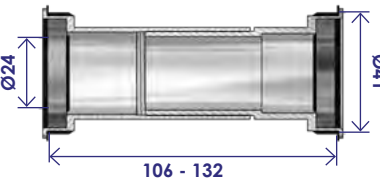

2019084
Shimano Fatbike^{1 2}

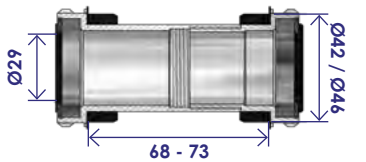

2019120
BB30 DUB
PF30 DUB

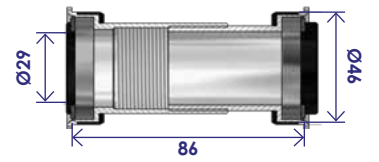

2019121
BB386 DUB

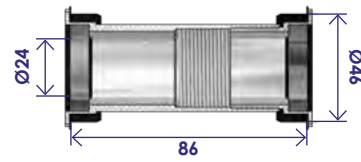

2020084
BB386 Shimano^{1 2}

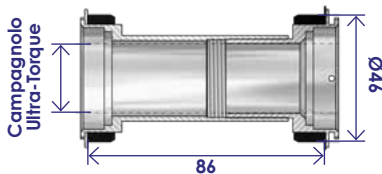

2020085
BB386 UT

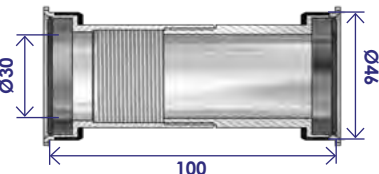

2020086
PF30 Fatbike

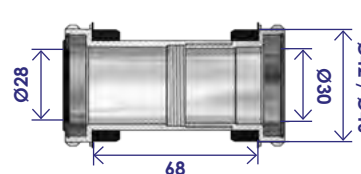

2020090
BB30 Praxis
PF30 Praxis

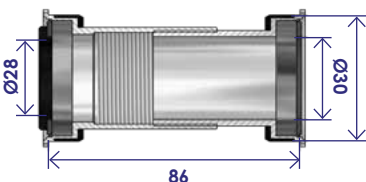

2020091
BB386 Praxis

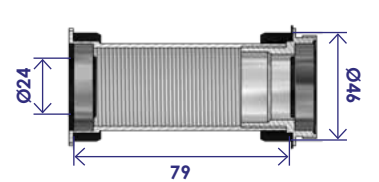

2021065
BB right Shimano^{1 2}

BRAKE

Rim brake pads

Disc brake pads

Disc brake rotors

Caliper adapters

Caliper bolts

Disc brake parts

Disc brake systems

CABLE

Superflex cables

Inner cables

Outer cables

Cable kits

Cable parts

HYDRO

Extending & repairing

Original brands

Hydro components

O-rings

ROTATION

Bearings

Headset bearings

Headset parts

Pulley wheels

Bottom bracket guide

Bottom brackets

Bottom bracket parts

TOOLS & MAINTENANCE

Maintenance

Cable tools

Hydro tools

More tools

Bottom bracket tools

WORKSHOP

Transit

Boxer

Partner

Caddy

Padfinder

Discovery

Bleed station

Scan the QR code for an online manual for (dis)assembling Elvedes twist fit bottom brackets using twist fit tool kit.



PRESS FIT

- ¹ Convertible to GXP with GXP reducer kit (2018080)
- ² Convertible to FSA with FSA bearing caps (page 72)

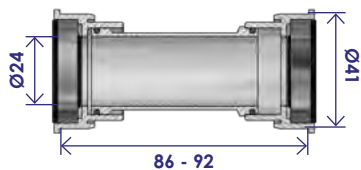

2018064
BB86/92 Shimano ^{1 2}

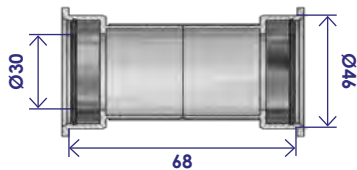

2019083
PF30

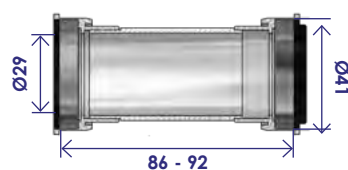

2022088
BB86/92 DUB

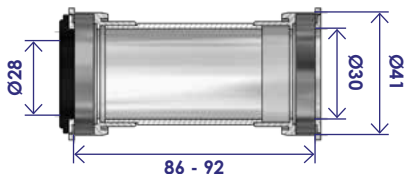

2020087
BB86/92 Praxis

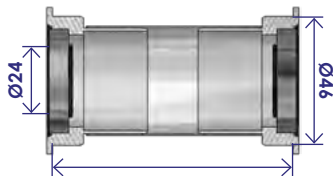

2021079
BB386 Shimano ^{1 2}

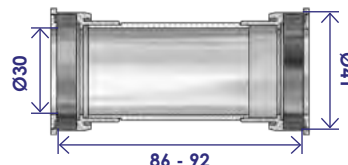

2022085
BB86/92

BEARING REPLACEMENT KIT

All replacement kit bearings are produced complying with ABEC 5.

- ¹ Includes bearing caps for Shimano and FSA
- ² Convertible to GXP with GXP reducer kit (2018080)



2018077
BB30



2018085
BB90/95 Trek only ^{1 2}



2019086
Campagnolo
Ultra - Torque

2019087
All Elvedes 24 mm
BB systems ^{1 2}

REPLACEMENT RINGS

For twist fit bottom brackets.

TWIST FIT MODEL		REPLACEMENT RING NON-DRIVE SIDE	REPLACEMENT RING DRIVE SIDE
2018069		2024131	2024131
2018070		2024133	2024132
2018071		2024138	2024138
2018073	BB30 Ø42 mm	2024136	2024128
	PF30 Ø46 mm	2024137	2024129
2018074		2024137	2024129
2019084		2024131	2024131
2019120	BB30 Ø42 mm	2024128	2024128
	PF30 Ø46 mm	2024129	2024129
2019121		2024138	2024138
2020084		2024135	2024135
2020085		2024134	2024135
2020086		2024138	2024138
2020090	BB30 Ø42 mm	2024128	2024128
	PF30 Ø46 mm	2024129	2024129
2020091		2024138	2024138
2021065		2024134	2024130

REPLACEMENT RINGS

For twist fit bottom brackets.

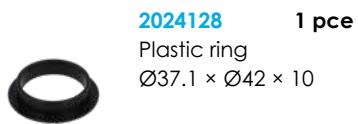

2024128 1 pce
Plastic ring
Ø37.1 × Ø42 × 10

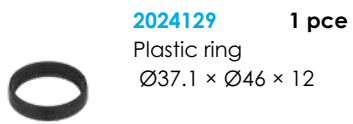

2024129 1 pce
Plastic ring
Ø37.1 × Ø46 × 12

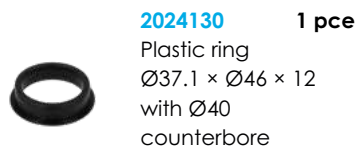

2024130 1 pce
Plastic ring
Ø37.1 × Ø46 × 12
with Ø40
counterbore



2024131 1 pce
Plastic ring
Ø39 × Ø41 × 10

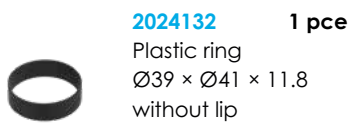

2024132 1 pce
Plastic ring
Ø39 × Ø41 × 11.8
without lip

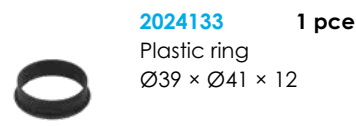

2024133 1 pce
Plastic ring
Ø39 × Ø41 × 12



2024134 1 pce
Plastic ring
Ø39 × Ø46 × 8
without lip

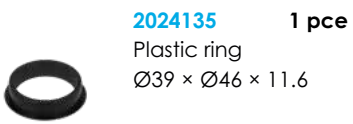

2024135 1 pce
Plastic ring
Ø39 × Ø46 × 11.6

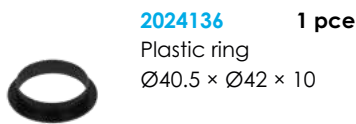

2024136 1 pce
Plastic ring
Ø40.5 × Ø42 × 10

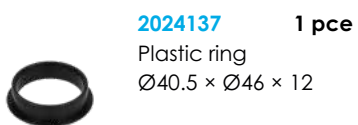

2024137 1 pce
Plastic ring
Ø40.5 × Ø46 × 12

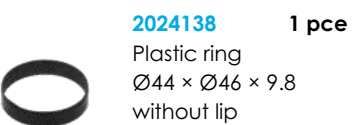

2024138 1 pce
Plastic ring
Ø44 × Ø46 × 9.8
without lip

BRAKE

- Rim brake pads
- Disc brake pads
- Disc brake rotors
- Caliper adapters
- Caliper bolts
- Disc brake parts
- Disc brake systems

CABLE

- Superflex cables
- Inner cables
- Outer cables
- Cable kits
- Cable parts

HYDRO

- Extending & repairing
- Original brands
- Hydro components
- O-rings

ROTATION

- Bearings
- Headset bearings
- Headset parts
- Pulley wheels
- Bottom bracket guide
- Bottom brackets

Bottom bracket parts

TOOLS & MAINTENANCE

- Maintenance
- Cable tools
- Hydro tools
- More tools
- Bottom bracket tools

WORKSHOP

- Transit
- Boxer
- Partner
- Caddy
- Padfinder
- Discovery
- Bleed station

ASSORTMENT BOX BOTTOM BRACKET SPACERS

2019070

Contains 157 pcs
Excludes 2022006 and 2022007



2022006 20 pcs
Spacer ring
Plastic
Ø30 × Ø24 × 0.2 mm



2022007 20 pcs
Spacer ring
Plastic
Ø36 × Ø30 × 0.2 mm



2019071 20 pcs
Spacer ring
Plastic
Ø30 × Ø24 × 0.5 mm

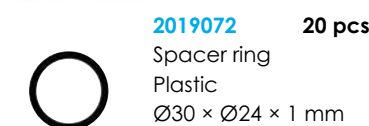

2019072 20 pcs
Spacer ring
Plastic
Ø30 × Ø24 × 1 mm

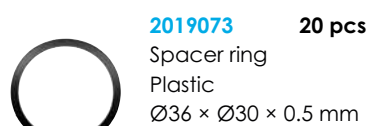

2019073 20 pcs
Spacer ring
Plastic
Ø36 × Ø30 × 0.5 mm

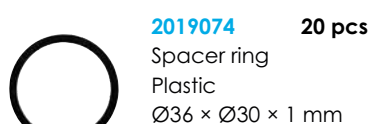

2019074 20 pcs
Spacer ring
Plastic
Ø36 × Ø30 × 1 mm



2019075 6 pcs
Spacer ring
Aluminium
Ø38 × Ø30 × 2 mm



2019076 4 pcs
Spacer ring
Aluminium
Ø38 × Ø30 × 5 mm



2019077 3 pcs
Spacer ring
Aluminium
Ø38 × Ø30 × 7 mm



2019078 2 pcs
Spacer ring
Aluminium
Ø38 × Ø30 × 9 mm



2019079 2 pcs
Spacer ring
Aluminium
Ø38 × Ø30 × 11 mm

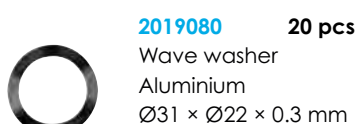

2019080 20 pcs
Wave washer
Aluminium
Ø31 × Ø22 × 0.3 mm

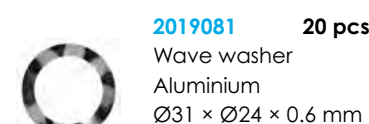

2019081 20 pcs
Wave washer
Aluminium
Ø31 × Ø24 × 0.6 mm

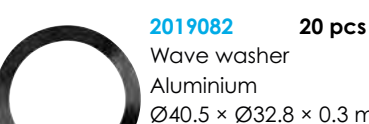

2019082 20 pcs
Wave washer
Aluminium
Ø40.5 × Ø32.8 × 0.3 mm



ASSORTMENT BOX BOTTOM BRACKET BEARING CAPS
2019056

2 pcs of every bearing cap
1 set GXP adapter

Scan QR code to
discover all
bearing caps



2018081 2 pcs
40 mm with edge
Shimano
Type A



2018082 2 pcs
37 mm without edge
Shimano
Type B



2018083 2 pcs
40 mm with edge
FSA 24 mm Mega Exo
Type C



2018084 2 pcs
37 mm without edge
FSA 24 mm Mega Exo
Type D



2019064 2 pcs
40 mm without edge
FSA 19 mm Mega Exo
Type E



2019065 2 pcs
37 mm without edge
FSA 19 mm Mega Exo
Type F



2019066 2 pcs
40 mm without edge
Shimano
(fits Trek)
Type A0



2019067 2 pcs
40 mm without edge
FSA 24 mm Mega Exo
(fits Trek)
Type C0



2018080
GXP reducer kit
24 mm to 22 mm

How to apply the
GXP reducer kit





GIVAPES

TOOLS & MAINTENANCE 5



ETHANOL CLEANER

2018037
40/60
500 ml



REFILL ETHANOL CLEANER

2018089
40/60
500 ml



DISC CLEANER

2016020
500 ml



GREASE GUN

2019035
Labels included
Grease not included
80 ml

Scan QR
how to refill



ORIGINAL NOZZLE

2020113
Short
Spare part
For grease gun



EXTENSION NOZZLE

2019036
Long
100 mm
For grease gun



SMALL NOZZLE

2023155
Ø4 mm
For rollerbrake
For grease gun



ASSEMBLY PASTE

2020212
Refill for grease gun
White
Not for carbon parts
110 g



ROLLERBRAKE GREASE

2019038
Refill for grease gun
Black

110 g



LITHIUM GREASE

2019037
Refill for grease gun
Blue

110 g



MINERAL OIL BLUE

For all mineral systems

Colour based on
Magura Royal Blood

2016006 100 ml
2015170 250 ml
2020239 1000 ml



MINERAL OIL RED

For all mineral systems

Colour based on
Shimano SM-DB-OIL

2016005 100 ml
2015169 250 ml
2020238 1000 ml



DOT OIL

For all DOT systems

2015171 100 ml

CABLE PRICKER DEVELOPED BY ELVEDES



CABLE PRICKER

2012029

Fits Ø4.1 and Ø4.9 mm outer cable



SPARE NEEDLE

2012029-1

For cable picker
incl. fixing bolt



CABLE CUTTER BASIC

2017070



CABLE CUTTER PROFESSIONAL

2009018

Felco C7



END CAP CRIMPING TOOL

2016093

For shift and brake end caps



FERRULE CRIMPING TOOL

2009019

For both ferrules and end caps



BRAKE

- Rim brake pads
- Disc brake pads
- Disc brake rotors
- Caliper adapters
- Caliper bolts
- Disc brake parts
- Disc brake systems

CABLE

- Superflex cables
- Inner cables
- Outer cables
- Cable kits
- Cable parts

HYDRO

- Extending & repairing
- Original brands
- Hydro components
- O-rings

ROTATION

- Bearings
- Headset bearings
- Headset parts
- Pulley wheels
- Bottom bracket guide
- Bottom brackets
- Bottom bracket parts

TOOLS & MAINTENANCE

- Maintenance
- Cable tools
- Hydro tools
- More tools
- Bottom bracket tools

WORKSHOP

- Transit
- Boxer
- Partner
- Caddy
- Padfinder
- Discovery
- Bleed station

NO MORE WASTING VALUABLE TIME LOOKING FOR COMPATIBLE FITTINGS!



2022058

Brake hose measurement tool kit with universal inserts.

Convenient tool to measure any unidentified brake hose and select the fitting type of hose insert.

Contains 4 pieces of each type of insert.
Packed in a luxurious storage box.



DEVELOPED BY ELVEDES

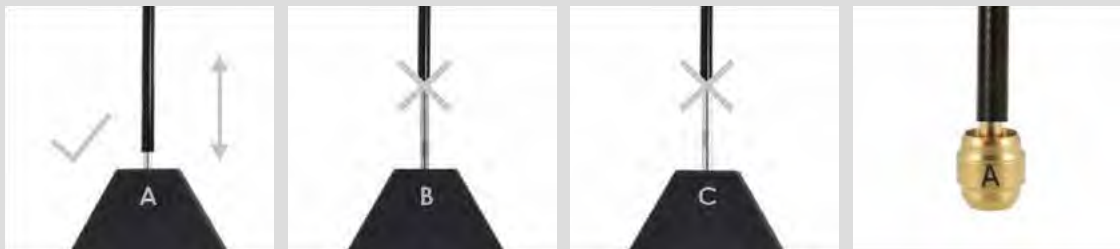

REFILL



2022059 10 pcs
Universal insert
Type A
For $\varnothing 2.1 - \varnothing 5$



2022060 10 pcs
Universal insert
Type B
For $\varnothing .3 - \varnothing 5$



2022061 10 pcs
Universal insert
Type C
For $\varnothing 2.5 - \varnothing 5$

PROFESSIONAL BLEEDING KIT

A complete kit per brand.
Fits the bleed station (pages 90 - 91)

Ensures clean and easy storage of your tools. Includes applicable high quality CNC adapters to prevent leakage. Includes 20 cm long tube(s) for great accessibility. Tubes are reusable for each adapter. Includes long lasting syringe(s) for mineral or DOT. Includes velcro straps to lend a helping hand.



- 2023102
- 2023103
- 2023104
- 2023105
- 2023106

Shimano incl. bleed cup with cap
SRAM
Magura
Tektro
Campagnolo

Scan QR code for more information



SPARE PARTS

Only compatible with parts for the professional bleeding kit



2023110
Adapter set for Shimano



2023111
Adapter set for SRAM



2023113
Adapter set for Tektro



2023112
Adapter set for Magura



2023114
Adapter set for Campagnolo



2023107 **2 pcs**
Link tube set
Incl. clips



2023108 **2 pcs**
Syringes for mineral oil



2023109 **2 pcs**
Syringes for DOT fluid



2023117
Syringe and bleed cup set for Shimano



2023115 **2 pcs**
Velcro straps

BRAKE

- Rim brake pads
- Disc brake pads
- Disc brake rotors
- Caliper adapters
- Caliper bolts
- Disc brake parts
- Disc brake systems

CABLE

- Superflex cables
- Inner cables
- Outer cables
- Cable kits
- Cable parts

HYDRO

- Extending & repairing
- Original brands
- Hydro components
- O-rings

ROTATION

- Bearings
- Headset bearings
- Headset parts
- Pulley wheels
- Bottom bracket guide
- Bottom brackets
- Bottom bracket parts

TOOLS & MAINTENANCE

- Maintenance
- Cable tools
- Hydro tools
- More tools
- Bottom bracket tools

WORKSHOP

- Transit
- Boxer
- Partner
- Caddy
- Padfinder
- Discovery
- Bleed station

HOSE PRICKER DEVELOPED BY ELVEDES



HOSE PRICKER

2022051

For Ø5 and Ø5.5 mm hydraulic hose



SPARE NEEDLE

2022051-1

For hose pricker
incl. fixing bolt



BASIC BLEEDING KIT

2024004

For mineral and DOT oil.
Incl. adapters for Shimano, Magura,
SRAM and Tektro.

How to bleed a
Shimano brake
system



BASIC BLEED ADAPTER SET



2020095
Shimano



2018047
Hayes



2020224
SRAM/Avid



2018048
Elvedes
HP4000



2018044
Tektro



2018043
Magura



2018045
Formula



2022045
Promax



2022106
Nutt



2023141
Bengal



2023142
Clarks



BLEED BLOCK

2022080

1 pce

Universal bleed block



BASIC OIL SYRINGES

2018040

2 pcs

Mineral oil syringes

2018041

2 pcs

DOT oil syringes



OPEN RING WRENCH 7 / 8

2017056

Specially designed for Shimano bleed bolt (7 mm)

For easy access to compression bolts (8 mm)



CROWS FOOT SPANNER 8 MM

2020094

For compression bolts (8 mm)

Fits 1/4" torque wrench



BASIC HOSE CUTTER

2019042

For smooth and burr-free cut hydraulic hose
Prevents leakage and damage of the hose

For consumer use

Spare blade included inside



PROFESSIONAL HOSE CUTTER

2019124

For smooth and burr-free cut hydraulic hose
Prevents leakage and damage of the hose



END PRESS

2017159

For fast and easily pressing inserts and banjos into hydraulic hose.

Not suitable for Magura HS



SPARE BLADE

2019232

For hose cutter
2019124



SPARE INSERT DRIVER

2018112

For end press
2017159

BRAKE

- Rim brake pads
- Disc brake pads
- Disc brake rotors
- Caliper adapters
- Caliper bolts
- Disc brake parts
- Disc brake systems

CABLE

- Superflex cables
- Inner cables
- Outer cables
- Cable kits
- Cable parts

HYDRO

- Extending & repairing
- Original brands
- Hydro components
- O-rings

ROTATION

- Bearings
- Headset bearings
- Headset parts
- Pulley wheels
- Bottom bracket guide
- Bottom brackets
- Bottom bracket parts

TOOLS & MAINTENANCE

- Maintenance
- Cable tools
- Hydro tools
- More tools
- Bottom bracket tools

WORKSHOP

- Transit
- Boxer
- Partner
- Caddy
- Padfinder
- Discovery
- Bleed station



INTERNAL CABLE GUIDE

2018057

Accessories included
For more liners see page 47

How to use the
internal cable
guide



**ACCESSORIES
REPLACEMENT SET**

2019270

For Internal cable guide
2018057



Magnetic pull wire

Pull wire

Magnet connector

Di2 connector

Cable and hose connector

Inner cable connector

**2-WAY
CONNECTOR**

2022068

For connecting outer
cables and
hoses end-to-end



**INNER TO OUTER
CABLE CONNECTOR**

2023182

For connecting a hose or outer
cable directly to a superflex pull
cable



**PICK-UP MAGNET
TOOL**

2020096

For easily picking up
internal cables, steel
bearing balls and more
40 mm



MECHANIC HEADLAMP

2019040

For perfect visibility during internal
cable guiding and frame
inspection

Beam adjustment function

Batteries (4 x AAA) not included



**INNER WIRE
TENSION TOOL**

2019041

For shift and brake inner
wires



**O-RING / SEAL
REMOVAL TOOL SET**

2020202

Specially designed for
easily removing and
replacing o-rings and
bearing seals



**DISC ALIGNMENT
TOOL**

2019043



MULTI TOOL

2018026

Multi tool for disc brake
and Centra-lock rings



Discover all
multi tool features





TWIST FIT TOOL KIT

2018087

Tool kit to (dis)assemble all Elvedes twist fit, thread fit and SRAM DUB bottom bracket.

- 16T Hollowtech II - 42.5 mm
- 12T SRAM DUB - 44 mm
- 12T Elvedes - 48.5 mm

How to use the Twist fit tool kit



BEARING SERVICE KIT

2018088

Tool kit to (dis)assemble bottom bracket bearings

How to use the Bearing service kit



BOTTOM BRACKET WRENCH

2018086

Bottom bracket wrench for all Elvedes twist fit and thread fit systems

- 16T Hollowtech II - 42.5 mm
- 12T Elvedes - 48.5 mm



SRAM DUB TOOL ADAPTER

2019069

For Elvedes Twist fit and thread fit and original SRAM DUB

- 12T SRAM DUB - 44 mm
- 12T Elvedes - 48.5 mm

BRAKE

- Rim brake pads
- Disc brake pads
- Disc brake rotors
- Caliper adapters
- Caliper bolts
- Disc brake parts
- Disc brake systems

CABLE

- Superflex cables
- Inner cables
- Outer cables
- Cable kits
- Cable parts

HYDRO

- Extending & repairing
- Original brands
- Hydro components
- O-rings

ROTATION

- Bearings
- Headset bearings
- Headset parts
- Pulley wheels
- Bottom bracket guide
- Bottom brackets
- Bottom bracket parts

TOOLS & MAINTENANCE

- Maintenance
- Cable tools
- Hydro tools
- More tools

Bottom bracket tools

WORKSHOP

- Transit
- Boxer
- Partner
- Caddy
- Padfinder
- Discovery
- Bleed station



ELVEDES
CADDY

 6805-80X 72mm replacement pads for 6804 carriage	 6804-80X 72mm V-brake pads	 6807-80X 55mm V-brake replacement pads	 6813-80X 55mm replacement pad for 6847 carriage	 6814-80X 72mm V-brake pads
 6815-80X 72mm V-brake pads with special groove design for WET conditions	 6816-80X 72mm V-brake pads symmetrical	 6817-80X 72mm V-brake pads	 6818-80X 72mm V-brake pads	 6819-80X 72mm V-brake pads

ELVEDES

ELVEDES

HYDRO BRAKE SHIPS

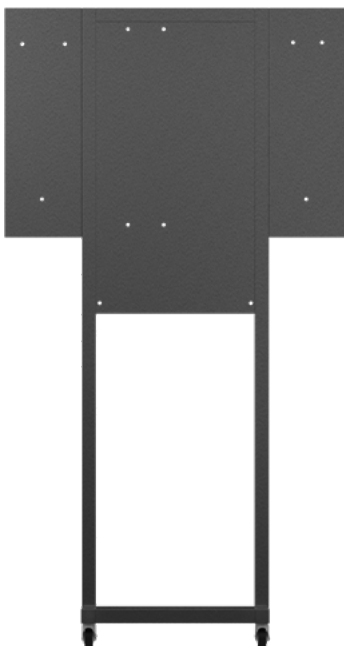

TRANSIT

2016042

No displays included

Dimensions
97 x 180 x 41 cm

In order to increase efficiency in the workshop, Elvedes has developed a compact all-in-one mobile frame.

This facilitates you to quickly and easily find all components you need for replacing cables and brake parts.

No displays included.

See pages 84 - 89

BRAKE

- Rim brake pads
- Disc brake pads
- Disc brake rotors
- Caliper adapters
- Caliper bolts
- Disc brake parts
- Disc brake systems

CABLE

- Superflex cables
- Inner cables
- Outer cables
- Cable kits
- Cable parts

HYDRO

- Extending & repairing
- Original brands
- Hydro components
- O-rings

ROTATION

- Bearings
- Headset bearings
- Headset parts
- Pulley wheels
- Bottom bracket guide
- Bottom brackets
- Bottom bracket parts

TOOLS & MAINTENANCE

- Maintenance
- Cable tools
- Hydro tools
- More tools
- Bottom bracket tools

WORKSHOP

- Transit
- Boxer
- Partner
- Caddy
- Padfinder
- Discovery
- Bleed station



BOXER

2017027

Dimensions
53 x 36 x 36 cm

Fasteners included



FREE CHOICE OF CABLE TYPES!

3 volume boxes stainless inner cable
4 volume boxes outer cable

See pages 35 + 38

Full display = display for free

PARTNER

2018115

Dimensions
53 x 14 x 7 cm

Smart fix system



BRAKE

- Rim brake pads
- Disc brake pads
- Disc brake rotors
- Caliper adapters
- Caliper bolts
- Disc brake parts
- Disc brake systems

CABLE

- Superflex cables
- Inner cables
- Outer cables
- Cable kits
- Cable parts

HYDRO

- Extending & repairing
- Original brands
- Hydro components
- O-rings

ROTATION

- Bearings
- Headset bearings
- Headset parts
- Pulley wheels
- Bottom bracket guide
- Bottom brackets
- Bottom bracket parts

TOOLS & MAINTENANCE

- Maintenance
- Cable tools
- Hydro tools
- More tools
- Bottom bracket tools

WORKSHOP

- Transit
- Boxer
- Partner
- Caddy
- Padfinder
- Discovery
- Bleed station



FREE CHOICE OF CABLE PARTS!

10 jars

See pages 43 - 47

Full display = display for free

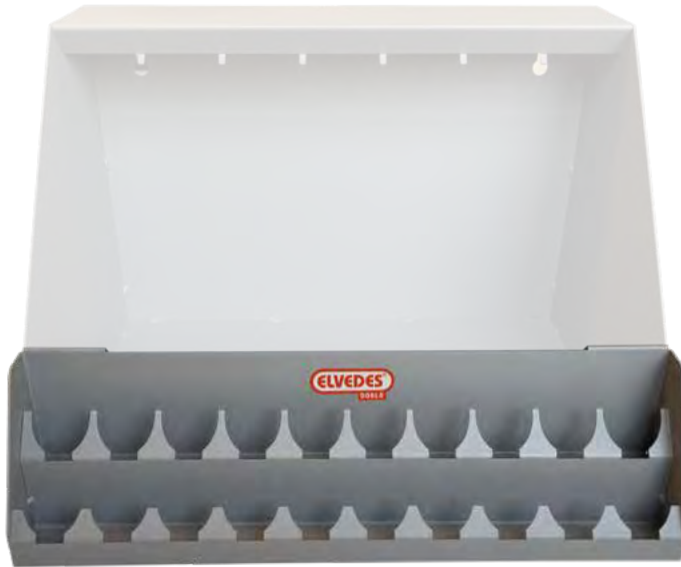

HYDRO SERVICE PACK

2024178

Extensive combo pack containing hoses and parts according to original recipes for Shimano Magura, Tektro, SRAM and Elvedes.

Excellent for:

- Extending
- Replacing
- Shortening
- Repairing
- Assembling

Includes:

Free BOXER display containing:
 10m hose for Elvedes
 10m hose for Magura
 10m hose for Shimano BH59
 10m hose for Shimano BH90
 10m hose for SRAM
 10m hose for Tektro 5.0
 10m hose for Tektro 5.5

Free DOBLO display containing:

ELV2012097	ELV2024069
ELV2024095	ELV2024100
ELV2012098	ELV2024070
ELV2024096	ELV2024101
⊕ ELV2020240	⊕ ELV2024087
ELV2024097	ELV2024102
ELV2024067	ELV2024093
ELV2024098	ELV2024103
ELV2024068	ELV2024094
ELV2024099	+1 gift

For refill see pages 49 - 51 and 53



HYDRO HOSE EXTENSION NIPPLE

Extend or repair original brand hydro hoses with the Elvedes hydro extension nipple.

Save a lot of time by avoiding internal cable guiding by easily extending your hose to the desired length.





CADDY

2017091

Dimensions
19.5 x 65 x 12.5 cm

Fasteners included

BRAKE

- Rim brake pads
- Disc brake pads
- Disc brake rotors
- Caliper adapters
- Caliper bolts
- Disc brake parts
- Disc brake systems

CABLE

- Superflex cables
- Inner cables
- Outer cables
- Cable kits
- Cable parts

HYDRO

- Extending & repairing
- Original brands
- Hydro components
- O-rings

ROTATION

- Bearings
- Headset bearings
- Headset parts
- Pulley wheels
- Bottom bracket guide
- Bottom brackets
- Bottom bracket parts

TOOLS & MAINTENANCE

- Maintenance
- Cable tools
- Hydro tools
- More tools
- Bottom bracket tools

WORKSHOP

- Transit
- Boxer
- Partner
- Caddy
- Padfinder
- Discovery
- Bleed station



FREE CHOICE OF RIM BRAKE PADS!

Choose 3 boxes with
25 pairs rim brake pads

See pages 11 - 13

Full display = display for free



PADFINDER

2017024

Dimensions
13 x 65 x 12.5 cm

Fasteners included



FREE CHOICE OF DISC BRAKE PADS!

Choose 4 boxes with
10 pairs disc brake pads

See pages 19 - 23

Full display = display for free



DISCOVERY

2016074

The Discovery can be used in 3 different settings:

1. Swing display (use additional arm)
2. Wall display
3. Counter display (use additional bottom base)

Necessary parts and fasteners included

Dimensions
38 x 65.5 x 15 cm

POSTER

2024002

Included with each Discovery

Separately available

BRAKE

- Rim brake pads
- Disc brake pads
- Disc brake rotors
- Caliper adapters
- Caliper bolts
- Disc brake parts
- Disc brake systems

CABLE

- Superflex cables
- Inner cables
- Outer cables
- Cable kits
- Cable parts

HYDRO

- Extending & repairing
- Original brands
- Hydro components
- O-rings

ROTATION

- Bearings
- Headset bearings
- Headset parts
- Pulley wheels
- Bottom bracket guide
- Bottom brackets
- Bottom bracket parts

TOOLS & MAINTENANCE

- Maintenance
- Cable tools
- Hydro tools
- More tools
- Bottom bracket tools

WORKSHOP

- Transit
- Boxer
- Partner
- Caddy
- Padfinder
- Discovery
- Bleed station



FREE CHOICE OF DISC BRAKE PADS!

Choose 100 pairs disc brake pads to fill the Discovery

See pages 19 - 23

Full display = display for free



BLEED STATION STARTER KIT

2023194

Workshop display to store up to 5 professional bleeding kits.

The starter kit includes 4 bleeding kits:

- 2023102** Shimano
- 2023103** SRAM
- 2023104** Magura
- 2023105** Tektro

Use the Bleed Station as counter or wall display.

Dimensions 41 x 29 x 16 cm



PROFESSIONAL BLEEDING KITS INCLUDED

See page 77



BLEED STATION 2023116

Workshop display to store up to 5 professional bleeding kits.

Bleeding kits not included.

Use the Bleed Station as counter or wall display.

Dimensions 41 x 29 x 16 cm



DISCOVER THE PROFESSIONAL BLEEDING KITS

See page 77

BRAKE

- Rim brake pads
- Disc brake pads
- Disc brake rotors
- Caliper adapters
- Caliper bolts
- Disc brake parts
- Disc brake systems

CABLE

- Superflex cables
- Inner cables
- Outer cables
- Cable kits
- Cable parts

HYDRO

- Extending & repairing
- Original brands
- Hydro components
- O-rings

ROTATION

- Bearings
- Headset bearings
- Headset parts
- Pulley wheels
- Bottom bracket guide
- Bottom brackets
- Bottom bracket parts

TOOLS & MAINTENANCE

- Maintenance
- Cable tools
- Hydro tools
- More tools
- Bottom bracket tools

WORKSHOP

- Transit
- Boxer
- Partner
- Caddy
- Padfinder
- Discovery
- Bleed station



Bike components.



**Elvedes
Youtube
Channel**
SCAN QR

**W
M
T**
**Visiting
address**

elvedes.com
info@elvedes.com
+31 (0)416 374 597
Grutter 7
NL-5253 RM Nieuwkuijk
The Netherlands

Item no. 2025001

